

Muncie PTO brought to you by Pro Gear & Transmission

REBUILT MUNCIE PTO

877-776-4600 | 407-872-1901

Pro Gear
AND TRANSMISSION

For Muncie PTO parts or service call Pro Gear & Transmission, Inc.
877-776-4600 / 407-872-1901 | parts@eprogear.com

MUNCIE

PTO SHAFT EXTENSIONS

Muncie Power Products, Inc. offers “PTO Shaft Extensions” for Allison 3000 and 4000 Series Transmissions. This innovative product provides the means to direct mount large hydraulic pumps using one of Muncie’s popular PTOs.



U.S. Pat. 6,263,749

PRODUCT FEATURES:

- Developed in cooperation with Allison Transmissions
- Replaces engine crankshaft drives for live power applications
- Direct mount large gear or piston hydraulic pumps to 3000 or 4000 Series transmissions
- Eliminate drive line maintenance of remote mounted pumps
- Available with CD10 Series Heavy Duty Constant Mesh (to 400 lb.-ft./542 Nm), CS10 or CS20 Clutch-Shift PTOs (Up to 500 lb.-ft./678 Nm)
- SAE “B”, SAE “B-B”, SAE “C”, and DIN 5462 outputs
- Perfect for Solid Waste, Snow and Ice Control, Utility Equipment and other applications

PTO SHAFT EXTENSION DIMENSIONS

MAX Pump Limit: 111 Lbs (50.4 Kg)

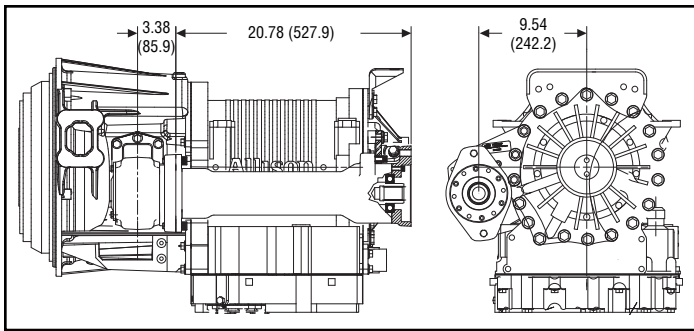

CD10 W/SHAFT EXTENSION

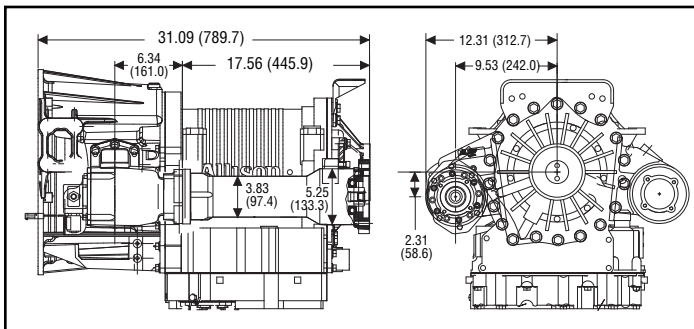

CS20 W/SHAFT EXTENSION

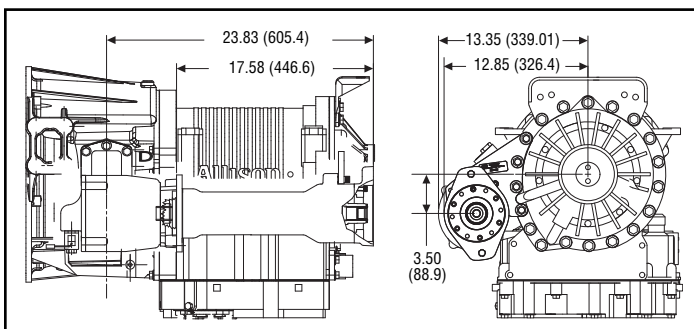

CS10 W/SHAFT EXTENSION

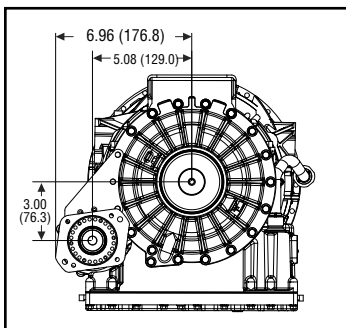

CS41 W/SHAFT EXTENSION

* Not currently available for retarder version transmissions or units with rear-mounted oil coolers. Transmission must have rear support installed as supplied by vehicle manufacturer.

** Not currently available for the 7 speed HD4070 transmission.

PTO SHAFT EXTENSION KITS

Shaft Kit Part No.	PTO Required (Not Included)	Allison Series*	Opening Location	Output (Pump) Mounting Type
49TA4125A	CD10-A10**-M3ZX	3000	LEFT	SAE B
49TA4126A	CD10-A10**-M3ZX	3000	LEFT	SAE B-B
49TA4127A	CD10-A10**-M3ZX	3000	LEFT	SAE-C
49TA4999A	CD10-A10**-M3ZX	3000	LEFT	SAE-C-2 & 4 Bolt
49TA4128A	CD10-A10**-M3ZX	3000	LEFT	DIN 5462
49TA4450A	CD10-A10**-M3ZX	3000	LEFT	SAE-B w/C-Shaft
49TA4133A	CD10-A10**-M1ZX	3000	RIGHT	SAE-C
49TA4134A	CD10-A10**-M1ZX	3000	RIGHT	SAE B-B
49TA4135A	CD10-A10**-M1ZX	3000	RIGHT	SAE B
49TA5000A	CD10-A10**-M1ZX	3000	RIGHT	SAE-C-2 & 4 Bolt
49TA4137A	CD10-A10**-M1ZX	3000	RIGHT	DIN 5462
49TA4451A	CD10-A10**-M1ZX	3000	RIGHT	SAE B w/C-Shaft
49TA4129A	CD10-A10**-M3ZX	4000**	LEFT	SAE B-B
49TA4130A	CD10-A10**-M3ZX	4000**	LEFT	SAE-C
49TA4941A	CD10-A10**-M3ZX	4000**	LEFT	SAE-C-2 & 4 Bolt
49TA4131A	CD10-A10**-M3ZX	4000**	LEFT	DIN 5462
49TA4132A	CD10-A10**-M3ZX	4000**	LEFT	SAE B
49TA4432A	CD10-A10**-M3ZX	4000**	LEFT	SAE B w/C-Shaft

Shaft Kit Part No.	PTO Required (Not Included)	Allison Series*	Opening Location	Output (Pump) Mounting Type
49TA4692A	CS20-A10**-H3IX	3000	LEFT	SAE B
49TA4698A	CS20-A10**-H3IX	3000	LEFT	SAE B-B
49TA4896A	CS20-A10**-H3IX	3000	LEFT	DIN 5462
49TA4788A	CS20-A10**-H3IX	3000	LEFT	SAE-C-2 Bolt
49TA5001A	CS20-A10**-H3IX	3000	LEFT	SAE-C-2 & 4 Bolt
49TA4838A	CS20-A10**-H3IX	3000	LEFT	SAE-B w/C-Shaft
49TA4694A	CS20-A10**-H1IX	3000	RIGHT	SAE B
49TA4699A	CS20-A10**-H1IX	3000	RIGHT	SAE B-B
49TA4897A	CS20-A10**-H1IX	3000	RIGHT	DIN 5462
49TA4789A	CS20-A10**-H1IX	3000	RIGHT	SAE-C-2 Bolt
49TA5002A	CS20-A10**-H1IX	3000	RIGHT	SAE-C-2 & 4 Bolt
49TA4839A	CS20-A10**-H1IX	3000	RIGHT	SAE-B w/C-Shaft
49TA4833A	CS20-A10**-H3IX	4000**	LEFT	SAE B
49TA4834A	CS20-A10**-H3IX	4000**	LEFT	SAE B-B
49TA4898A	CS20-A10**-H3IX	4000**	LEFT	DIN 5462
49TA4835A	CS20-A10**-H3IX	4000**	LEFT	SAE-C-2 Bolt
49TA5003A	CS20-A10**-H3IX	4000**	LEFT	SAE-C-2 & 4 Bolt
49TA4840A	CS20-A10**-H3IX	4000**	LEFT	SAE-B w/C-Shaft
49TA4841A	CS20-A10**-H3IX	3000-83T	LEFT	SAE-B-2 & 4 Bolt

Shaft Kit Part No.	PTO Required (Not Included)	Allison Series*	Opening Location	Output (Pump) Mounting Type
49TA4495A	CS10-A10**-H3ZX	3000	LEFT	SAE B-B
49TA4506A	CS10-A10**-H3ZX	3000	LEFT	SAE-C-2 Bolt
49TA4837A	CS10-A10**-H3ZX	3000	LEFT	SAE-C-2 & 4 Bolt

Shaft Kit Part No.	PTO Required (Not Included)	Allison Series*	Opening Location	Output (Pump) Mounting Type
49TA5004A	CS41-A10**-H3ZX	4000**	LEFT	SAE-C-2 & 4 Bolt
49TA4877A	CS41-A10**-H3ZX	4000**	LEFT	SAE-C-2 Bolt
49TA4880A	CS41-A10**-H3ZX	4000**	LEFT	DIN 5462
49TA4881A	CS41-A10**-H3ZX	4000**	LEFT	SAE-B-w/o Shaft



MP01-07 (Rev. 3-08) Printed in the U.S.A.
© Muncie Power Products, Inc. 2008

Muncie Power Products, Inc. Member of the Interpump Hydraulics Group
General Offices and Distribution Center • P.O. Box 548 • Muncie, IN 47308-0548
(765) 284-7721 • FAX (765) 284-6991 • E-mail info@munciepower.com
Web site <http://www.munciepower.com>

Drive Products, Exclusive Agents for Canada, ISO Certified by an Accredited Registrar



Pro **Gear**

AND TRANSMISSION, INC.

If you have any questions about any Munice Product, do not hesitate to call us so we can help you with finding the right PTO, part or anything else you may need.

906 West Gore St
Orlando, FL 32805
USA

Contact Us:

1-866-776-4600

1-407-872-1901

Fax:

1-407-872-6235