

Brought to you by Pro Gear & Transmission courtesy of Muncie PTO

REBUILT MUNCIE PTO

877-776-4600 | 407-872-1901

Pro Gear
AND TRANSMISSION

For parts or service call Pro Gear & Transmission, Inc. 877-766-4600 /
407-872-1901 parts@eprogear.com



**Muncie[®]
Power
Products**

KEEP IN VEHICLE
READ OPERATING INSTRUCTIONS
INSIDE BEFORE OPERATING PTO

PTO INSTALLATION & OWNER'S MANUAL

**FOR MUNCIE FR SERIES PTO USED ON THE
FORD TORQSHIFT[®] AUTOMATIC TRANSMISSION**



PTO OWNER'S MANUAL

FOR MUNCIE FR SERIES PTO USED ON THE
FORD TORQSHIFT® AUTOMATIC TRANSMISSION



TABLE OF CONTENTS

Section 1	PTO Installation	1.1
Section 2	Activation Installation	2.1
	FR Series Electric/Hydraulic Shift System	2.1
	PTO Instructions & Tests	2.2
Section 3	Owner's Manual	3.1
	PTO Shifting Procedures & Precautions	3.1
	PTO Operation	3.1
	PTO Maintenance	3.2
	PTO Torque & Horsepower Ratings	3.3
	PTO Troubleshooting Guide	3.3
	Power Take-Off Warranty	3.4

WARNING

- ⚠ DO NOT ATTEMPT TO INSTALL OR SERVICE ANY POWER TAKE-OFF WITH THE TRUCK ENGINE RUNNING. PUT IGNITION KEYS IN YOUR POCKET BEFORE GETTING UNDER TRUCK.
- ⚠ DO NOT ALLOW TRUCK ENGINE TO BE STARTED WHILE WORKERS ARE UNDER TRUCK.
- ⚠ BEFORE WORKING ON A VEHICLE PLACE TRANSMISSION IN NEUTRAL OR PARK, SET BRAKES, AND IMMOBILIZE TRUCK WHEELS WITH SUITABLE CHOCKS.
- ⚠ BE SURE TO BLOCK ANY RAISED BODY OR MECHANISM BEFORE WORKING ON OR UNDER EQUIPMENT.
- ⚠ INSTALLED POWER TAKE-OFFS MUST NEVER BE SHIFTED IN OR OUT OF GEAR BY ANY MEANS EXCEPT BY THE CONTROLS IN THE CAB OF THE TRUCK.
- ⚠ STAY CLEAR OF SPINNING DRIVESHAFTS TO AVOID BECOMING ENTANGLED AND INJURED.
- ⚠ IT SHALL BE THE RESPONSIBILITY OF THE INSTALLER OF A MUNCIE POWER TAKE-OFF TO DECIDE WHETHER TO INSTALL GUARDS IN THE PTO AND/OR DRIVELINE AREA BECAUSE OF POTENTIAL EXPOSURE TO DANGER.
- ⚠ THIS IS BECAUSE MOST MUNCIE PTOs ARE INSTALLED BY EQUIPMENT DISTRIBUTORS OR MANUFACTURERS AND THEREFORE, THE RESPONSIBILITY OF THE INSTALLATION IS BEYOND THE CONTROL OF MUNCIE POWER PRODUCTS.
- ⚠ INSTALLERS ARE TO INSURE THAT PTO COMPONENTS DO NOT INTERFERE WITH ANY CHASSIS COMPONENTS, INCLUDING BUT NOT LIMITED TO VEHICLE CROSSMEMBERS, FRAME RAILS, DRIVESHAFTS, EXHAUSTS, CONVERTERS, FUEL LINES, ETC. WHILE VEHICLE IS STATIONARY OR MOBILE.

The PTO is supplied with a packet containing warning labels. If you did not receive any, or if you need extra, you may order them, no charge, by phone, email or mail. They are available through your nearest Muncie distributor, by calling Muncie at 1-800-FOR-PTOS (1-800-367-7867), email: info@munciepower.com or by mail at the address below:

Muncie Power Products, Inc. • P.O. Box 548 • Muncie, IN 47308-0548

SECTION 1

PTO INSTALLATION

ALL INSTALLERS MUST READ THE FOLLOWING

PTO AND ACTIVATION KIT INSTALLATION INSTRUCTIONS

Always wear safety glasses. Read entire manual before starting installation.

IMPORTANT: *Disconnect vehicle battery prior to installing electrical and electric/hydraulic activation kits.*

- A.** Vehicle manufacturers may have specific locations for accessing electrical power and activating hydraulics. The body builder manual or company representative for the vehicle chassis should be contacted prior to installing electrical or hydraulic systems.
- B.** Route wires and activation lines away from rotating and high temperature components. Use appropriate looms and bulk head pass-thru's wherever possible to avoid rubbing through insulation or tubing and causing an electrical short or oil leak.
- C.** Follow all Federal Motor Vehicle Safety Standards (FMVSS) for your vehicle.
- D.** Where electrical grounds are indicated, be sure that they are good grounds, with straight paths to the vehicle battery ground. (Many vehicle cabs are insulated from the vehicle frame and a weak ground is a very common cause for malfunctions).
- E.** When installing hydraulic components, be certain to follow common installation and testing procedures. If you are not familiar with acceptable installation procedures request instructions and guidance from the hydraulic equipment supplier.
- F.** Caution should be taken by installer with any PTO installation to insure components do not interfere with any chassis component during installation or when vehicle is operated.
- G.** Cold weather start conditions require that the transmission be started and warmed prior to engaging PTO and using equipment. Hydraulic pumps should be run at idle and under no load conditions to allow oil to warm before activating hydraulic system.

IMPORTANT INFORMATION:

There is valuable information contained in the Ford "Super Duty F-Series Body Builders Layout Book". You can obtain a copy of this book by faxing your request to "Body Builder Coordinator" at 1-734-414-2971. Include your street address and desired vehicle and model year. It can also be found on the Ford website at <http://www.fleet.ford.com/truckbbas/>

PTO INSTALLATION INSTRUCTIONS

1. There is a packet with the PTO which contains 4 WARNING LABELS. Before adhering the labels, make sure the surfaces are free of dirt and grease. Place the labels supplied as follows:

There are two (2) labels which measure approximately 4" x 8" which are to be placed on the outside of the vehicle frame rail, making them easy to be seen by anyone who might go under the truck or near the PTO. One label is to be placed on each side of the vehicle.

Should the body installed on the chassis cover the frame rail, place the label on the body in a position easily visible by anyone who might go under the vehicle or near the PTO.

Do not paint over labels.

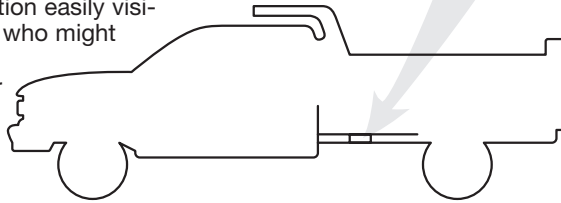
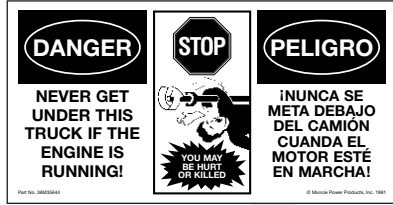
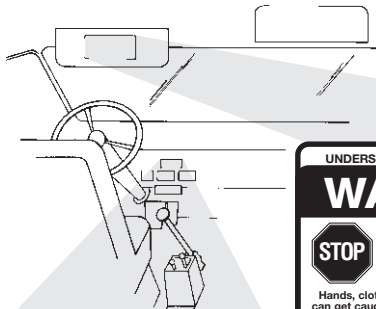

Figure 1.1

There are two (2) 4" X 8" labels supplied and one is to be placed on each side of the vehicle.

2. The 2" x 3" PTO Equipped Caution Label is to be placed within the cab of the vehicle and in easy view of the vehicle operator. It should be located near the PTO control, when the control is installed in the vehicle dash (See Figure 1.2). This label directs the operator to read the PTO operating instructions on the "Visor Label". The Visor Label 3-1/2" x 6-1/4" is to be placed on the visor on the operator's side of the vehicle (See Figure 1.2).



<p>THIS VEHICLE IS EQUIPPED WITH A POWER TAKE-OFF</p> <p>CAUTION</p> <p>READ & FOLLOW OPERATING INSTRUCTIONS BEFORE USING THIS EQUIPMENT.</p> <p>(SEE SUN VISOR)</p>	<p>Este vehículo está equipado con una TOMAFUERZA</p> <p>PRECAUCIÓN</p> <p>Lea y siga las instrucciones de manejo en el parascal antes de usar esta maquinaria.</p> <p>(Atención al parascal)</p>
<p>© Muncie Power Products, Inc. 2021 Part No. 30M20552 (Rev. 5-01)</p>	

<p>UNDERSTAND THIS LABEL BEFORE USING POWER TAKE-OFF (PTO)</p> <p>WARNING</p> <p>STOP NEVER GET UNDER THIS TRUCK IF THE ENGINE IS RUNNING!</p> <p>Hands, clothes, hair, etc. can get caught on spinning shafts and U-joints.</p> <p>YOU MAY BE HURT OR KILLED.</p> <p>It is against Federal Law to try to fix PTO driven machinery if the engine is running. Always turn the engine off. Then, put the keys in your pocket. (OSHA 1910.147)</p> <p>Part No. 36137507</p>		<p>HOW TO USE THE POWER TAKE-OFF (PTO)</p> <p><i>Clutch Shift PTOs for the Light Truck Automatic Transmissions</i></p> <p>For Stationary Applications:</p> <ol style="list-style-type: none"> 1. Place Transmission Selector in Park. 2. Let Engine Idle. 3. Engage PTO Rocker Switch. 4. Release PTO Switch. 5. Green Light Should Activate. 6. Bring Engine Slowly to Operating Speed. <p>For Mobile Applications:</p> <ol style="list-style-type: none"> 1. Follow Procedures Above. 2. Apply Brakes. 3. Place Shift Selector in Any Drive Range. <p>Released by Muncie Power Products, Inc. 1997</p>

Figure 1.2

3. While seated in the vehicle and with transmission in “Park”, start engine and listen to the sounds of transmission and engine before installing PTO. A noise in the transmission gear may be more noticeable after PTO is installed.

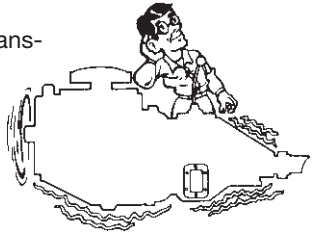

Stop engine.

4. Installation of the PTO is made easier if the transmission shifter linkage is disconnected and the cable bracket is temporarily removed. This is the large black bracket located directly rearward of the PTO opening. Be sure to retain these components for re-installation after the PTO is installed. On Ford vehicles 2005 and later, modification of bracket is required. See Ford bulletin QVM-112.

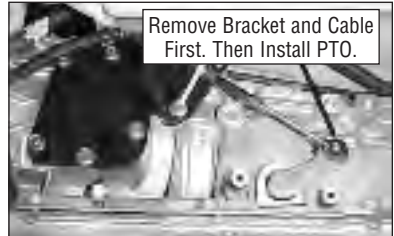

5. Do not drain transmission fluid, but be prepared for a small amount of oil to escape from opening. Avoid contact with this oil because it may be HOT.

Remove cover plate. Remove cover gasket and set it aside for reuse when mounting PTO. **Do Not discard the gasket. It must be used to install the PTO.**



13739089

Clean mounting pad. Inspect bolt holes in aperture for thread sealant used on OEM bolts. Clean these internal threads with wire brush to clear any material, if found.

6. Check transmission for proper PTO driver gear and location.

Check PTO driver gear for condition. A nick or blemish may cause excessive noise when PTO is mounted.



7. Remove the activation kit components from the PTO carton. Included in this kit is a 90 street elbow. This elbow DOES NOT have an orifice in it.

8. Install the elbow into the main pressure port located directly below the PTO opening. Install this elbow as far as it will go while positioning the port towards the rear of the vehicle.



- 9.** Locate the hose with a JIC swivel on one end and an 1/8" NPT male thread on the other. Install this main pressure activation hose to the 1/8" NPT elbow in the main pressure port.



- 10.** Route this hose assembly to clear any moving components of transmission.



FR62/FR63 INSTALLATION (FR64 GO TO STEP #15)

The FR62/FR63 PTO is shown here.

- 11.** Locate the stud kit provided with the PTO. The PTO is provided with (3) 12-point capscrews; (2) shoulder studs, and nuts; 1) step stud and whiz lock nut. (20TK4525)



- 12.** The shoulder studs are to be installed in the top mounting hole and the lower rear mounting hole.



- 13.** The stud is to be mounted in the lower, center mounting location. The whiz-lock nut included is to be used in this location.

- 14.** Reposition the transmission gasket that was removed in Step 4, onto the transmission making sure that the larger holes in the gasket/shim are located directly over the alignment shoulder studs. Place the PTO on to the transmission opening.



FR64 INSTALLATION (FR62/FR63 GO TO STEP #21)

The FR64 PTO is shown here.



- 15.** The FR64 is supplied with (2) 12 point capscrews; (2) shoulder studs,nuts; (1) hex head capscrew with flat washer and o-ring; 1) step stud and nut. (20TK4542)



12 Point Capscrew



Shoulder Stud

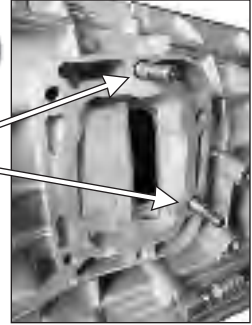

- 16.** The shoulder studs are installed the same as the FR62/FR63 locating one in the top mounting hole and the other in the lower rear mounting hole.

- 17.** Insert the step stud into the lower forward mounting hole.

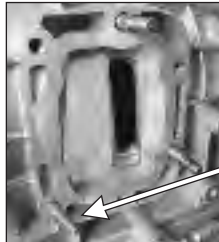

Step Stud



- 18.** Reposition the transmission gasket that was removed in step 4, onto the transmission making sure that the larger holes in the gasket/shim are located directly over the alignment studs.

- 19.** Locate the long hex head capscrew, flat washer and o-ring. Place the flat washer onto shaft of capscrew, then place the o-ring over the shaft and slide up to the bottom of the head. There is a second o-ring that is located in the hole near the mounting pad. Make sure there is an o-ring in this location.



- 20.** Insert the capscrew into PTO housing and through the hole and o-ring in the PTO mounting pad.

Place the PTO up onto the transmission opening while aligning the mounting holes over the shoulder studs. Screw the hex head capscrew into the bottom mounting hole in the transmission pad.



NOTE: There is an o-ring groove located inside this hole near the mounting pad. Be sure that the o-ring remains in position as capscrew is inserted.

FR62/FR63 AND FR64 INSTALLATION

CAUTION: It is important to check for gaps between the PTO and transmission and make sure gear teeth are properly meshed before tightening nuts, regardless of which PTO model you are installing.

- 21.** Hold the PTO in position and install the nuts onto the shoulder studs. Install the 12 point capscrews in the forward two mounting holes and upper rear mounting hole. Tighten the capscrews and nuts to approximately 40 ft. lbs., the step stud nut to 17 ft. lbs.



12 Point Capscrew

- 22.** Checking the backlash is not required when using the approved Ford furnished gasket. Should the gasket be damaged, obtain a Ford original equipment replacement. The Muncie part number for this gasket is 13T39089 (Not included with the PTO.)

NOTE: Never use silicone type sealant on PTO/transmission mounting surface, as proper backlash cannot be attained.

- 23.** Approximating the torque is required for capscrew locations where a torque wrench can not be applied. This can be accomplished by the installer comparing the tightness of an accessible capscrew. Tighten this with the wrench to be used on the hard-to-reach capscrew. Check the torque. Repeat until the installer “gets the feel” of this torque. Then tighten the hard-to-reach capscrew so that it approximates this torque.

- 24.** Locate the solenoid manifold and remove protective cap plugs. Install the (3) straight thread fittings into the ports as shown. In the port labeled “IN” install the JIC tee fitting. In the ports marked “CL” (Clutch activation) and “EXH” (Exhaust) install JIC elbow fittings.



- 25.** Install the pressure switch into the block using pipe thread sealant.

FR62/FR63 INSTALLATION (FR64 GO TO STEP #29)

- 26.** Install the special orifice fitting (43T37385) into the port located in the bottom of the main PTO housing. NOTE: The orifice fitting is plated "silver", bagged, and labeled to identify it as the orifice fitting. Install the pipe thread hose end from the lube line into this fitting.

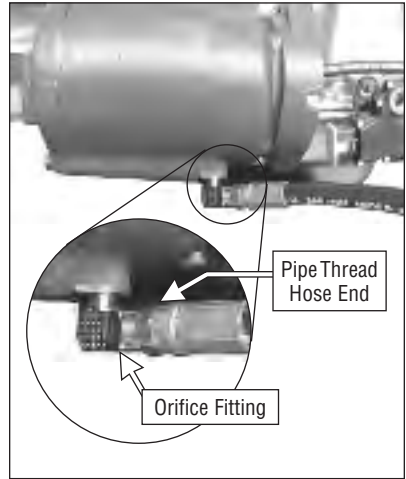

- 27.** Connect the main pressure hose and the lubrication hose to the JIC tee fitting installed in the "IN" port on the block.

- 28.** Remove the cap plugs from the closed end cover on the PTO. Install the straight thread fitting into the port that is pointed towards the ground. Install the pipe thread fitting into the port located on the end of the cover.

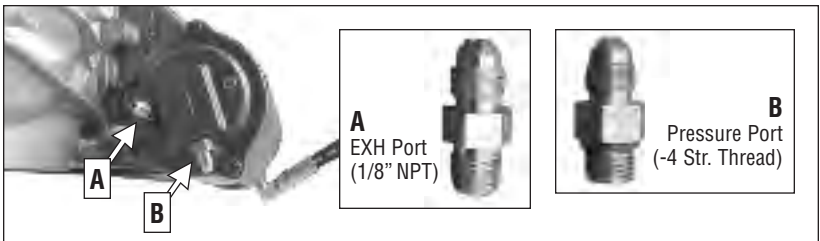

FR64 INSTALLATION (FR62/FR63 GO TO STEP #32)

- 29.** Install the special orifice fitting (43T37385) into the port located forward of the long hex head cap-screw. NOTE: the orifice fitting is plated "silver", bagged, and labeled to identify it as the orifice fitting. Install the pipe thread hose end from the lube line into this fitting. Be sure the route this hose away from the forward vehicle driveshaft.



- 30.** Connect the main pressure hose and the lubrication hose to the JIC tee fitting installed in the "IN" port on the block.
- 31.** Remove the cap plugs from the closed end cover. The FR64 has a straight thread port which is pointing up (B) and the exhaust port is a pipe thread pointing towards the front of the vehicle (A).

(B) Pressure Port

(A) Exhaust Port



FR62/FR63 AND FR64 INSTALLATION

- 32.** Locate the hose that has a JIC swivel hose end on both ends of the line. Connect one end to the pressure port on the PTO (the one with the straight thread fitting) and connect the other end to the "CL" port on the solenoid block.

A JIC to JIC elbow fitting is provided for use at the PTO if additional clearance for hose routing is required.



- 33.** Locate the remaining hose that also has two JIC swivel hose ends. Connect one end to the "EXH" port on the solenoid block. The other end can be connected to a 90 degree JIC to JIC fitting supplied with the kit and then connect to the fitting in the end cover.



90 JIC to JIC
Can be used as needed
to ease hose routing.

- 34.** Find a suitable location forward and above the PTO opening to install the activation solenoid.
- 35.** The solenoid is provided with mounting hardware. A small bracket maybe fabricated to attach to an existing hole in the cross member or frame rail.

- 36.** Use cable ties to make sure hoses are routed away from the exhaust and away from any rotating components.

Route the wiring harness from the vehicle front passenger compartment to the solenoid valve.

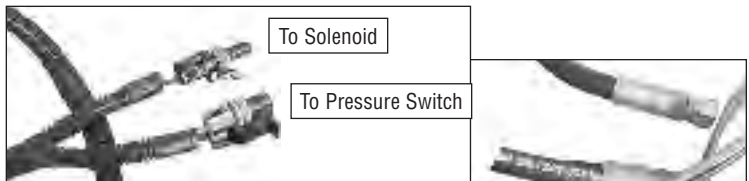
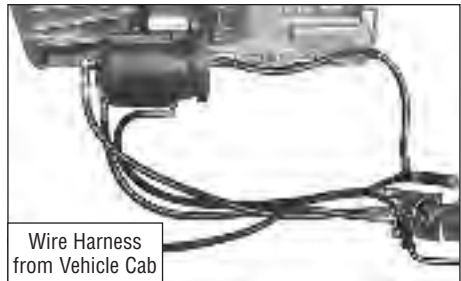

- 37.** The solenoid connector is a Weather-Pack type. The pressure switch connector is a Metri-Pack type.

- 38.** Make the connections to the pressure switch and to the solenoid valve.



- 39.** The wire harness separates at a 4 wire connector. The connector is designed to fit through the 5/8" grommet provided. Separate the harness and feed the harness end through the grommet in the passenger barrier.

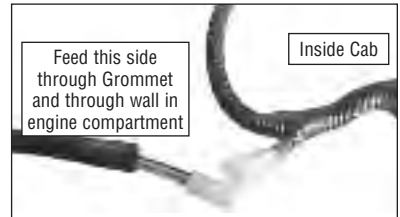

- 40.** Located at the 4 wire connector is a ground lead. Route this lead directly to the battery or battery terminal and ground this terminal.

- 41.** When routing the wire harness be sure to tie the harness away from heat sources (Exhaust, Manifold, etc.) and away from rotating components (Driveshafts, Belts, etc.)

Ford F-Super Duty Vehicles 2003 thru 2004

For either FR Series with standard "H" shift option turn page

For either FR Series with optional "Z" shift option turn to page 1.23

For either FR Series with optional "Q" shift option or FORD APCM turn to page 1.23

Ford F-Super Duty Vehicles 2005 and Later

For either FR Series with optional "D" or "G" shift option turn to page 1.12

Ford or International Cab Forward (CF Series) 2006 and Later

For either FR Series "I" shift option turn to page 1.16

All Model Years

For either FR Series with optional SPD-1000A turn to page 1.24



- 42.** Remove the access panel located below the steering wheel.

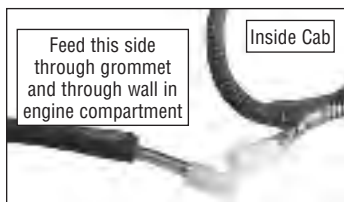

- 43.** Locate the 4 wire connector that was fed through the passenger barrier and connect this connector to interior half of the PTO harness.



Remove Panel

Locate Plug at Bottom of Panel

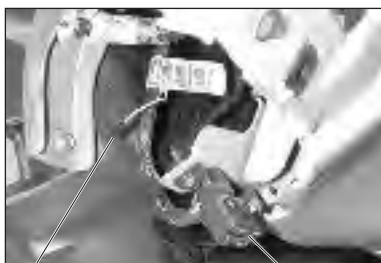

Circuit 294 (White with Light Blue Trace)

Follow Data Link Connector Wire

Ford Vehicle Model Year 2003-04 "H" Shift Option

- 44.** Make sure that the ignition switch is turned OFF and that the key is removed from the ignition.

From within the access panel area locate the Ford supplied blunt cut power wire and ECM wire. The power wire is color coded White w/Lt. Blue stripe and the ECM wire is coded Blue w/Yellow stripe.

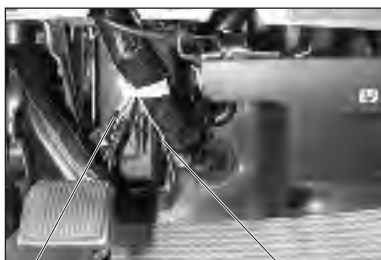

*Body Builder Pass-Thru Circuits (Red, Dk Blue, White & Black)
Clean Tachometer Output (Light Green w/White Trace)*

Circuit 322 (Light Blue w/Yellow Trace)

Find the "Data Link Connector" located below access panel and follow the wire up behind panel.

The wire harness is supplied with two matching color coded wires with a butt splice attached. Strip the Ford wires and crimp the matching wire butt splices located on the PTO harness.

The Muncie Blue/Yellow to the Ford Blue/Yellow, and the Muncie White to the Ford White/Blue.

Care must be taken because Ford also provides 4 "Customer Pass Through Circuits" for connection of auxiliary body builder's circuits.

Be sure to look carefully at the wires before connecting them.

It is important that if you need to weld on the vehicle that the Ford recommended procedures be followed. These include disconnecting the battery, PCM, and ABS electrical connections.

45. Observe the Dashboard locations suggested in photo for the mounting of the PTO activation switch. (Typically this location is clear on vehicles with 4x2 and 4x4 with manually shifted transfer case.) Remove the instrument panel by pulling out; be careful to disconnect the power-point from the back as you gain access. Use the Dash faceplate to mark then cut opening for the rocker switch in a location without structure interference behind the panel.

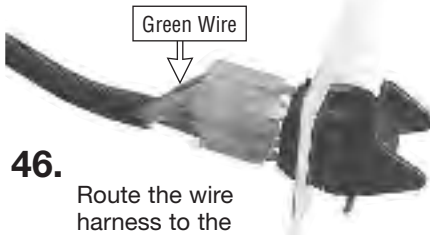
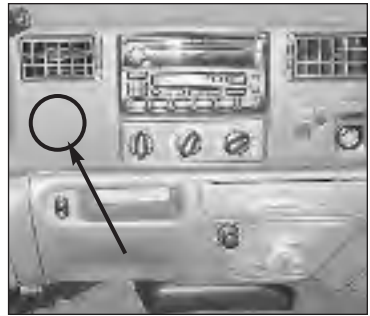

46. Route the wire harness to the bracket. Push the rocker switch through the face plate and into the bracket. Attach the switch connector block to the switch. Be sure that the green wire in the connector is at the top of the switch.



47. Plug relay into socket provided on wiring harness. (The relay comes standard plugged into the harness from Muncie.)

All FR Models, All Years

48. Start the truck engine (**with transmission and PTO in neutral**) for a few seconds and listen for unnatural noises. **Stay clear of rotating components.** Should an unnatural noise occur then **shut off** engine and remove the PTO and examine the PTO and transmission for defects.
Caution: Keep PTO/transmission running time as short as possible.
49. Check transmission oil level and if required, fill to proper level per instructions found in the vehicle owner's manual. Run engine for 5 to 10 minutes to check for leaks. **Stay clear of rotating components.**
50. **Shut off engine. Inspect the cap screws to make sure they are properly tightened.** Mounting bolts should be checked on a regular basis for tightness.

The wiring harness provided can be used for 2008 & later Ford F-Super Duty and for the 2005 thru 2007 model years. Both versions of FORD harnesses are used in the descriptions below. The 2005 thru 2007 wiring codes are in (). After making appropriate connections return to Step 48.

Diesel 2005 thru 2007 AND 2008 & later Ford with Torqshift automatic transmission.

STANDARD INSTALLATION

1. Install the wiring harness at the PTO activation valve and pressure switch as described in the FR series installation manual.
2. In the cab near the parking brake pedal you will find the Ford blunt cut wires for connection to the PTO wiring harness. (Fig. 1) Easier access to the wires can be obtained by removing the access panel from under the steering wheel and removing the screws holding the fuse box. (Fig. 2)
3. Connect the solid Muncie ORANGE wire to the Ford YELLOW/GREEN wire, circuit PTO (solid ORANGE '05)
4. Connect the Muncie ORANGE/BLUE wire to the Ford BLUE/WHITE wire, circuit PTO-OK (ORANGE/BLUE '05). On vehicles built BEFORE 2008 Ford did not have this wire connected to the vehicle PCM; therefore connect this wire to battery ground.
5. Connect the Muncie ORANGE/RED wire to the Ford WHITE/BROWN wire, circuit PTO_VREF (ORANGE/RED '05)
6. Connect the Muncie ORANGE/YELLOW wire to the Ford GREEN wire, circuit PTO_RPM (ORANGE/YELLOW '05)
7. Connect the Muncie ORANGE/BLACK wire to the Ford GREY/PURPLE wire, circuit PTO_GND (ORANGE/BLACK '05)
8. Install the Muncie switch either into the Muncie switch bracket or dash. Plug the switch harness into the switch so that the GREEN wire in the harness is at the TOP of the switch.
9. Plug the relay into the relay socket.
10. Locate a 12v ignition switched power source. This may be found by locating the Ford PURPLE wire (WHITE/BLUE) wire near the data link connector or by going to the fuse box. Connect the Muncie WHITE wire to this power source.

6.8L V10 GAS 2005 thru 2007 AND 2008 & later Ford with Torqshift automatic transmission.

STANDARD INSTALLATION

1. Install the wiring harness at the PTO activation valve and pressure switch as described in the FR series installation manual.
2. In the cab near the parking brake pedal you will find the Ford blunt cut wires for connection to the PTO wiring harness. (Fig. 1) Easier access to the wires can be obtained by removing the access panel from under the steering wheel and removing the screws holding the fuse box. (Fig. 2)
3. Connect the Muncie solid ORANGE wire to the Ford YELLOW/GREEN wire, circuit PTO (solid ORANGE '05).
4. Connect the Muncie ORANGE/BLUE wire to the Ford BLUE/WHITE wire, circuit PTO-OK (ORANGE/BLUE '05).
5. Connect the Muncie ORANGE/YELLOW wire to the Ford GREEN wire, circuit PTO-RPM (ORANGE/YELLOW '05).
6. Connect the Muncie ORANGE/WHITE wire to the Ford BLUE/GREEN wire, circuit PTO-ENGAGE (ORANGE/WHITE '05).
7. Install the switch either into the switch bracket or dash. Plug the switch harness into the switch so that the GREEN wire in the harness is at the TOP of the switch.
8. Plug the relay into the relay socket.
9. Locate a 12v ignition switched power source. This may be found by locating the Ford PURPLE wire (WHITE/BLUE '05) wire near the data link connector or by going to the fuse box. Connect the Muncie WHITE wire to this power source.

Figures 1 & 2 are at top of next page

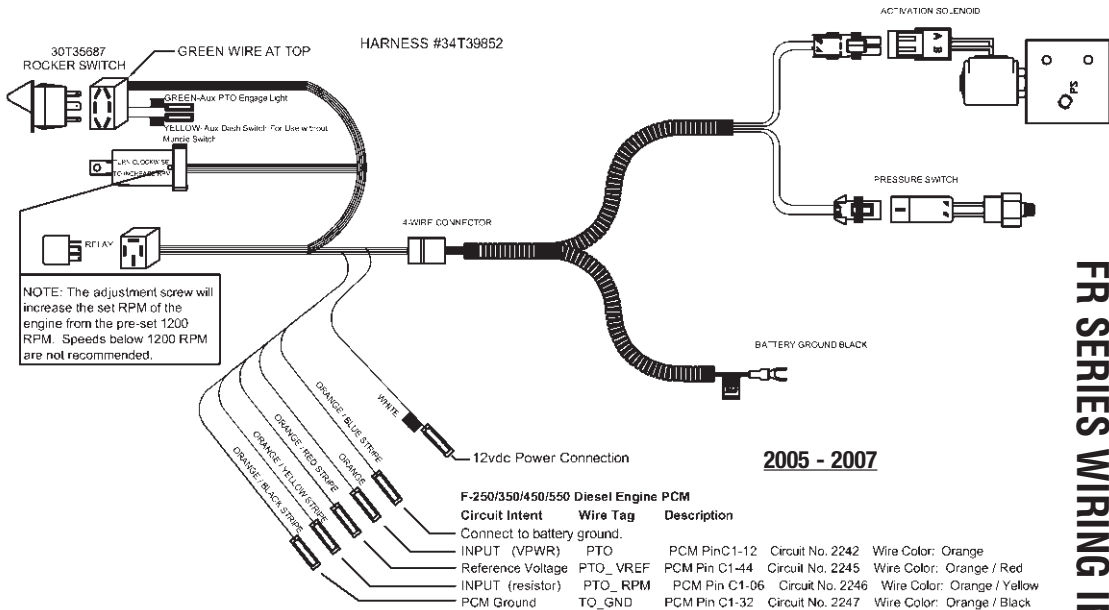

2008 Model Year Color Codes

Muncie Wire	Ford Wire	Tag
WHITE	PURPLE	N/A
ORANGE/BLUE	BLUE/WHITE	PTO-OK
ORANGE	YELLOW/GREEN	PTO
ORANGE/RED	WHITE/BROWN	PTO-VREF
ORANGE/YELLOW	GREEN	PTO-RPM
ORANGE/BLACK	GREY/PURPLE	PTO-GND

FORD 2005 AND LATER - DIESEL ENGINE FR SERIES WIRING INSTRUCTION



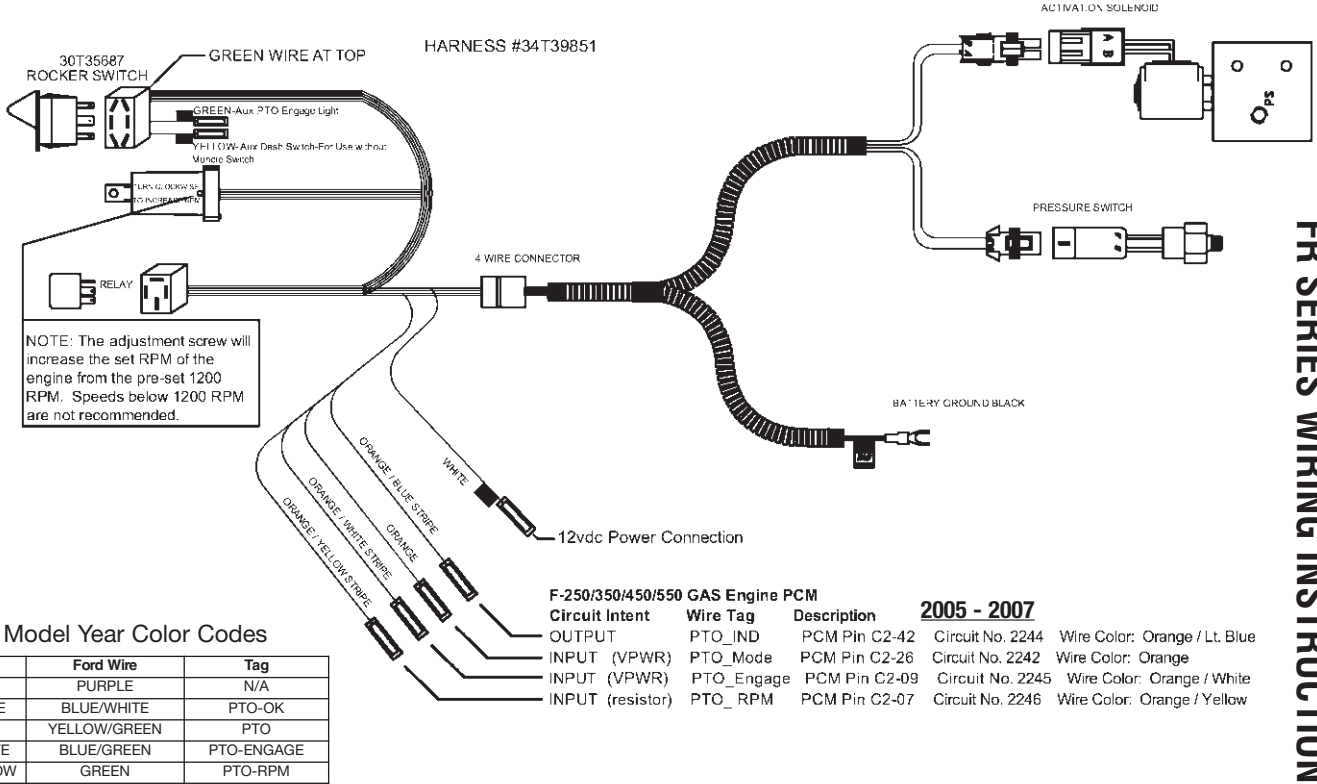

**FORD 2005 AND LATER - GAS ENGINE
FR SERIES WIRING INSTRUCTION**

OPTIONAL: Using the FORD supplied AUX switch (2005 and Later) (Upfitter switches) (Gas or Diesel):

1. Wire the harness as listed above.
2. Do not use the Muncie rocker switch. Connect YELLOW wire from the Muncie switch socket to the wire from the desired Ford AUX switch. The Muncie PTO will not draw more than 10 Amps, so any of the switches can be used.
3. Install a PTO indicator light in the vehicle dash (not supplied). Connect the GREEN wire from the rocker switch socket to the light and connect the other side of the Light to 12vdc power source.

RPM Adjustment with Muncie Control

1. Muncie wiring harnesses include a variable control for adjusting the

- vehicle throttle advance to a speed other than the preset 1200 RPM. Locate the module with the set screw adjustment and the label indicating adjustment.
2. Turn the adjustment screw clockwise to increase RPM (Max 2300 RPM) (Fig. 3). Use tachometer to set speed. Mount under the dash.
3. Once the speed is adjusted, the engine will advance to this speed every time the PTO is activated.
4. The speed can not be adjusted below the recommended 1200 RPM operating speed set by Ford. This ensures adequate PTO activation pressure from the transmission and torque converter lock-up.



FIG. 3

SEIC Enable/Disable Conditions

Vehicle Conditions to Enable SEIC (all are required)	Vehicle Conditions that Disable SEIC (any one required)	Gas Engine	Diesel Engine
Parking brake applied.	Parking brake disengaged.	Yes	Yes
Foot off of service brake	Depressing service brake	Yes (See Note-1)	Yes (See Note-2)
Vehicle in PARK (automatic trans.)	Vehicle taken out of PARK	Yes	Yes
Foot off of clutch (manual trans.)	Clutch depressed	Yes	Yes (See Note-2)
Foot off of accelerator pedal		Yes	Yes
Vehicle speed is 0 mph (stationary)		Yes	Yes
Brake lights functional	Brake light circuit disconnected	Yes	Yes
Engine at a stable base idle speed		Yes	Yes
	Transmission Oil Temperature (TOT) Limit exceeds 240 degrees F.	Yes (See Note-1)	No
	Engine Coolant Temperature Limit (ECT)	Yes (See Note-1)	No
	Catalyst Temperature Limit	Yes (See Note-1)	No

Note-1: A “change-of-state” at the “PTO-Request” circuit is required to re-invoke SEIC. When a disabler is seen by the PCM the “PTO-Indicator” circuit changes from “ground-source” to “open-circuit”. After approximately 3 seconds SEIC drops out, returning the engine speed to base idle. For vehicle-stationary operation, the automatic transmission torque converter unlocks as engine speed proceeds below 1200 rpm. To re-initiate SEIC the operator must turn off the aftermarket PTO switch (removing command voltage to the “PTO-Mode” circuit) and turn it back on again.

Note-2: SEIC is automatically re-activated after approximately 3 seconds after the disabling condition is removed.

Required PTO Wiring for CF Series with Ford Motor Company Automatic Transmission

WARNING:

Installing a transmission-mounted PTO without the required PTO wiring may result in transmission failure.

GENERAL INFORMATION

To minimize the risk of transmission damage, PTO controls must be integrated into the vehicle wiring.

Applying vehicle battery voltage to the "PTO Request" wire will

- (1) place the transmission in PTO mode and
- (2) elevate idle engine speed when certain conditions (described below) are met.

This connection is part of the Muncie PTO control system; failing to connect will result in under-capacity of PTO and can cause PTO clutch wear, resulting in rapid contamination of transmission fluid and internal transmission damage.

The output wire indicates when the elevated idle is active. The "PTO Enable" output is used to restrict PTO operation to stationary only.

An input wire is to control the PTO lamp in the instrument cluster. Applying vehicle battery voltage to the "PTO Engaged" wire will illuminate the PTO lamp.

All required PTO circuit connections are blunt cut wires supplied with the vehicle and are located behind the cab on the left frame rail near the transmission. The Muncie wiring harness provided will allow you to make these connections.

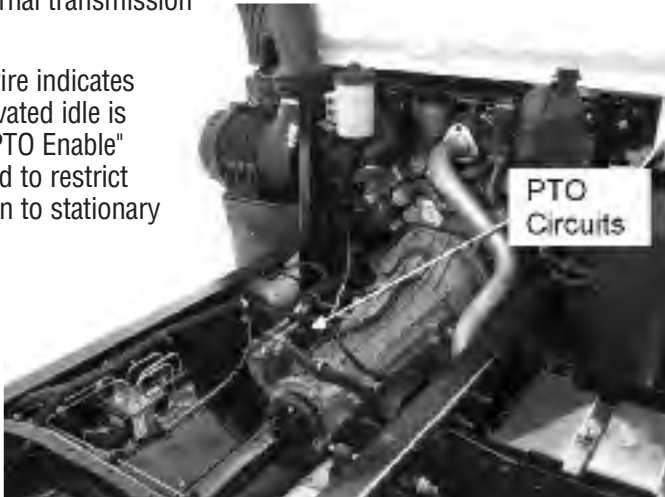

Elevated Idle Operation

(1) When the PTO Request input transitions from open circuit to vehicle battery voltage and

(2) When the conditions in Table 1 are met, the engine will ramp to 1200 RPM and the PTO Enable output will be activated.

While in this mode, normal engine hand controls are available; however, the engine will maintain an engine speed between 1200 and 2400 RPM. The engine will remain in this mode until either

(1) the PTO Request input is an open circuit or

(2) one or more of the conditions in Table 1 are no longer met.

NOTE: The transition of the PTO Request input is required to initiate the elevated idle mode.

PTO Elevated Idle Conditions:

Park Brake Applied
Service Brake released
Vehicle in Park
Accelerator Pedal not pressed
Vehicle speed is 0
Engine speed is below 1200RPM

Table 1

Circuit Intent	Wire Name	Description
Input (VPWR)	PTO Request	BLUNT CUT WIRE CIRCUIT NO. 2335 WIRE COLOR: PURPLE/LIGHT GREEN Applying vehicle battery voltage to this wire will request the transmission enter PTO mode and will elevate engine speed if conditions are met.
Output PTO	Enable	BLUNT CUT WIRE CIRCUIT NO. 2334 WIRE COLOR: BROWN/YELLOW A low-side driver, changing from "open-circuit" to "ground" indicating elevated idle (PTO) is active. Intended for turning on a relay coil. Maximum current is 1 amp.
Input (VPWR)	PTO Engaged	BLUNT CUT WIRE CIRCUIT NO. 2336 WIRE COLOR: RED/ORANGE Applying vehicle battery voltage to this wire will activate the PTO lamp in the instrument cluster, and removing vehicle battery voltage will deactivate the PTO lamp.
Input (VPWR) 2006-2007 ONLY	ECM Remote Preset PTO Enable	BLUNT CUT WIRE CIRCUIT NO. 2231 WIRE COLOR: LT. BLUE/RED Applying vehicle battery voltage to this wire will enable the Remote Preset PTO engine operation. This input, or ECM Remote Variable PTO Enable, is required for PTO.
Input (VPWR) 2006-2007 ONLY	ECM Remote Variable PTO Enable	BLUNT CUT WIRE CIRCUIT NO. 2232 WIRE COLOR: RED/LT. BLUE Applying vehicle battery voltage to this wire will enable the Remote Variable PTO engine operation. This input, or ECM Remote Preset PTO Enable, is required for PTO.
Input (VPWR) 2008 +	PTO Resume	BLUNT CUT WIRE CIRCUIT NO. 1924 WIRE COLOR: DARK GREEN/WHITE Applying vehicle battery voltage to this wire command PTO engine speed to preset value (1500rpm.)

CF SERIES - PTO WIRING INSTRUCTIONS

1. Follow installation instructions for FR Series PTO IN03-01 until step 41.
2. Locate a 12V dc source in under the dash and connect the fused Red wire. Locate a battery ground and attach the black wire with the ring terminal to the ground.
3. Disconnect the 4-wire connector and feed the connector through the firewall. reconnect making sure connector is indexed correctly and that all terminals are making contact.
4. Route the PTO harness away from rotating components and heat sources. Locate the blunt cut wires in a loom near the transmission PTO opening.
5. The Muncie wiring harness has color coded wires with butt splice connectors attached. Strip the Ford/International wires and connect Pink/Lt Green wire to Purple/Lt. Green wire, Brown/Yellow wire to Brown/Yellow wire, Red/Orange wire to the Red/Orange wire and to Ford wire Red/Blue or Blue/Red on 2006-2007 models or Green/White on 2008 and later model (See note below)
6. Attach the Black wire with ring terminal on the Muncie harness to a battery ground. See diagram on page 1.19.
7. Plug the Metri-Pack connector into the pressure switch and connect the Weather-Pack connector to the activation solenoid.
8. Continue the PTO installation as described in the IN03-01 installation manual from step #45.

*NOTE:

If you are in possession of the Muncie FR series PTO with the “I” shift option or the 34T40128 wiring harness, you will need to connect the Muncie Pink/Lt. Green wire to the Chassis Purple/Lt. Green wire AND the ECM Remote Wire (either the Lt. Blue/Red or Red/ Lt. Blue, your choice, 2006-2007 only; 2008+ connect Green/White wire.) found at the chassis bundle near the PTO opening.

The Preset PTO will allow the operator to advance the engine throttle to a preset RPM higher than the initial 1200 RPM (On 2008 & later, the preset is 1500 RPM.) The value is programmed by the dealer. To activate, while in PTO mode, turn on the cruise control and push the cruise (+) button.

The Variable PTO will allow the operator to increase the engine throttle to any value above the initial 1200 RPM. To activate, while in PTO mode, turn on the cruise control. Press the (+) button until desired speed is reached and then let go of the button (On 2008 & later, computer will need to be reprogrammed by dealer to have Variable PTO option.)

PTO WIRING FOR CE SERIES WITH FORD MOTOR COMPANY AUTOMATIC TRANSMISSION

(Harness Part Number 34T40128)

SEE DETAILS ON PREVIOUS PAGE

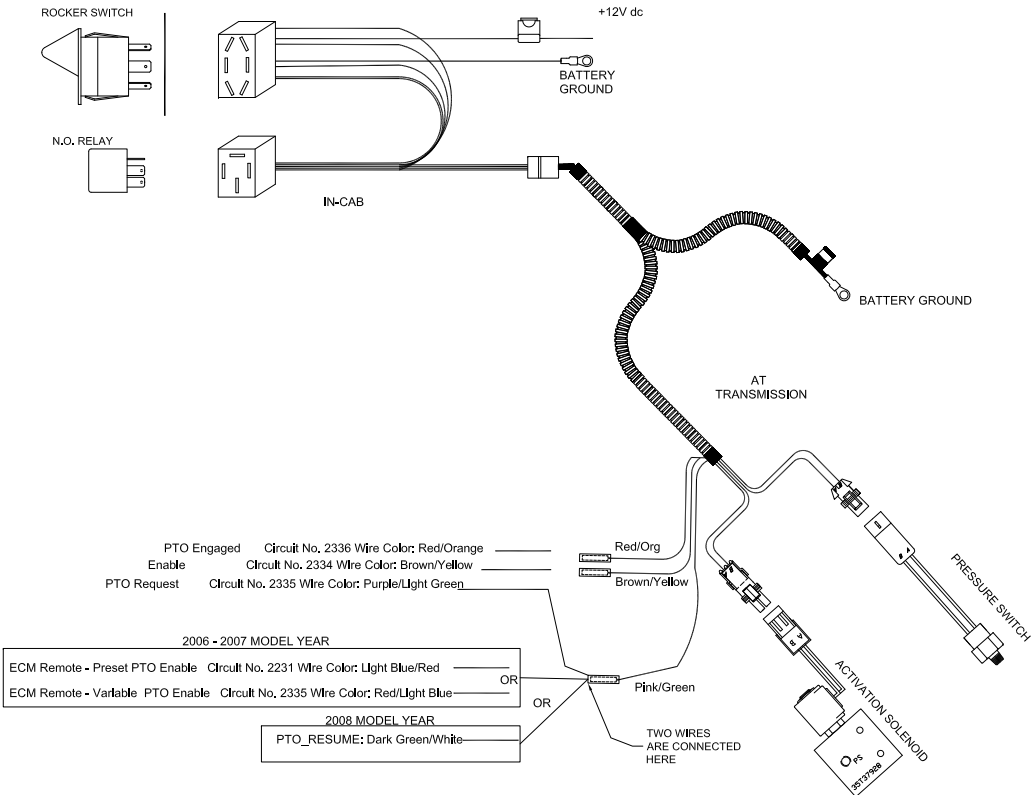

FR64 INSTALLATION (FR62/FR63 GO TO STEP #57)

- 51.** When mounted to a 4x4 chassis, the FR64 requires the use of a special hydraulic pump mounting which is found on the Muncie PF3-***-16QSRL pumps. This pump uses thru-bolts to mount to the FR64 PTO. This is the only pump to be used on the FR64 on 4x4 chassis.



On 4x2 chassis you may use this pump with the FR64 or use the standard PF3-***-16ASRL with the "T" pump mount option.

The 1-1/4" round keyed shaft is available on the FR64 PTO for mounting to 4x2 chassis. Follow information on page 1.13 for drive-line installations.



- 52.** The FR64 for mounting on 4x4 applications is provided with a special pump pilot adapter ring which converts the PTO to the "N" output option*. Look for this pilot ring before installing the pump. Without this adapter ring the output designator is "T" which is for use on 4x2 chassis.

* In May 2007 this ring was eliminated and special pilot was machined into housing.

- 53.** If the ring is not present, order adapter ring 14T39149 and flathead capscrew 19T39031 from your PTO supplier or Muncie Power Products, Inc. The ring is held in place with the flat head capscrew. Install this into the hole provided and tighten until head is flush with surface. (Only units prior to May 2007)

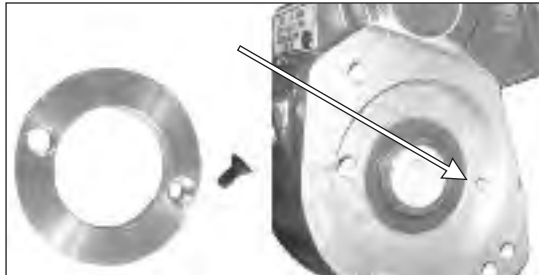

- 54.** The PF3 pump is supplied assembled and does not require dis-assembly. The proper mounting capscrews and flat washer are provided with the pump. It is critical that the proper mounting capscrews be used, if you did not receive capscrews, then contact Muncie Power Products for the correct mounting hardware.



- 55.** Before installation, place the flat washers over the shaft of the capscrew. (There is to be 1 or 2 washers used depending on the pump size used.)



- 56.** Place the pump into the PTO output mounting by aligning the splines and pilot. Align the thru-bolt mounting holes and insert capscrews with flat washers and **tighten the capscrews to 36-38 ft. lbs.** Note that the pump orientation is with the pump body offset pointing down.

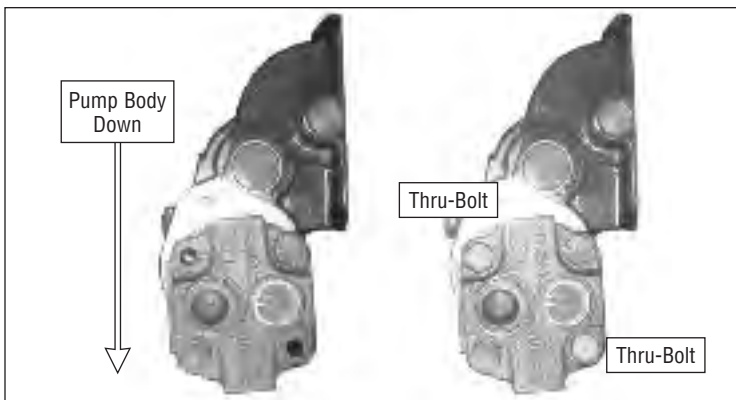

FR62/FR63 AND FR64 INSTALLATION

- 57.** If your system contains a driveline between the PTO and another product and if you have noise in your system that was not there before, the angularity or phasing of your driveline may be the cause. Check driveline angularity and reduce total angularity per recommendation on chart and be sure the PTO shaft is parallel within 1.5 degrees to the pump shaft (or driven unit).

Max. Speed (RPM)	Max. TJA "A"
3500	5°
3000	5°
2500	7°
2000	8°
1500	11°
1000	12°

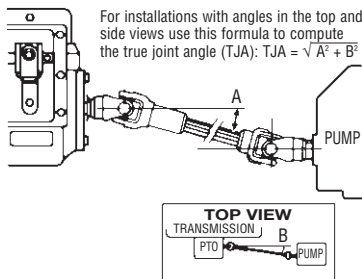

PTO WITH DIRECT COUPLE HYDRAULIC PUMP INSTALLATION

The Muncie PF series hydraulic pumps installed on the 4x4 are of special design. This design allows for interference problems to be minimized.

Before bolting the pump to the PTO, place a non-seizing compound or grease on the PTO shaft and pump shaft. Muncie supplied PTOs are pre-lubricated and do not require lubrication at installation.

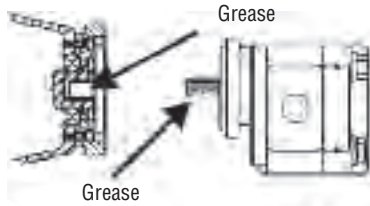

[FR62/FR63 Series] When mounting hydraulic pumps weighing over 20 lbs., or exceeding 12" in length, or tandem or multiple section pumps, a bracket should be attached to the rear of the pump and to the transmission to support the pump and to inhibit movement in all directions.

Bracket Required to Inhibit Movement

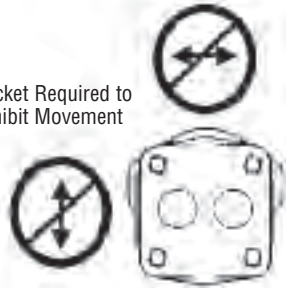

The bracket should attach to two or more transmission bolts. The bracket design should assure that there is no stress or force exerted on the pump or PTO shaft during the installation of the bracket.

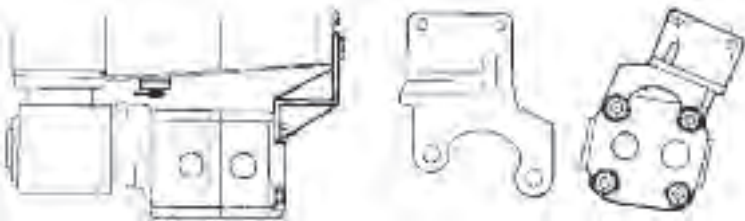

If vertical supports are greater than 20 degrees off of perpendicular with the transmission main shaft then a reinforced "Z" bracket must be used. Reinforce horizontal members to prohibit flexing at bend or weld. Attach the bracket at the pump bolt closest to the center of gravity of the pump.

Pumps without attaching holes or studs are sometimes supported by welding an eyelet to a hose adapter fitting, installing this into the pump port, and then attaching your bracket to it.



FR62/FR63 and FR64

NOTE: When making hydraulic connections to the pump, it is important to route the hydraulic lines away from the front and rear vehicle drive shafts. It is important to route hydraulic lines away from exhaust manifold and pipes. It is recommended that heat shields for the hydraulic hoses be installed on the 4x4 gas engine applications. Contact your hydraulic hose supplier for their recommendations.

- 58.** Re-install the cable and cable bracket that were removed in Step #4.
- 59.** Complete installation by placing warning labels as indicated on borders of the decals. Placement examples are illustrated on page 1.2.

PTO INSTALLATION WITH SPD-1000A SYSTEM PROTECTION DEVICE (All Shift Options and Model Years)

Requires purchase of 34T37753 and SPD-1000A
not included with PTO

1. Make the PTO installation as described in Steps 1-47.

2. Obtain the 4-wire connector on the Muncie PTO Harness and plug in the wire harness adapter 34T37753 sold separately. The adapter is designed to



assembly only in one direction.

3. Find the Red wire on this adapter harness which goes to the 4-wire connector and connect this wire to the SPD harness Red wire as shown in Diagram "A".
4. Connect the SPD Blue wire to the Green wire on the adapter harness as shown in Diagram "A".
5. Locate Ford Green/White wire (2006-2007) or Ford Blue wire (2008+) (pg 1.10) and connect the Orange SPD wire.
6. Connect the Black SPD wire to a good ground at the fuse panel or battery (not to the cab).
7. Connect the White wire to an Overspeed light if required, sold separately. Ground the other terminal of the Light.
8. Mount the SPD after making the calibration setting as described in the SPD installation manual.

SECTION 2

ACTIVATION INSTALLATION

ACTIVATION KIT DIAGRAM

FR SERIES ELECTRIC/HYDRAULIC SHIFT SYSTEM

Activation Kit No. 43TK4521

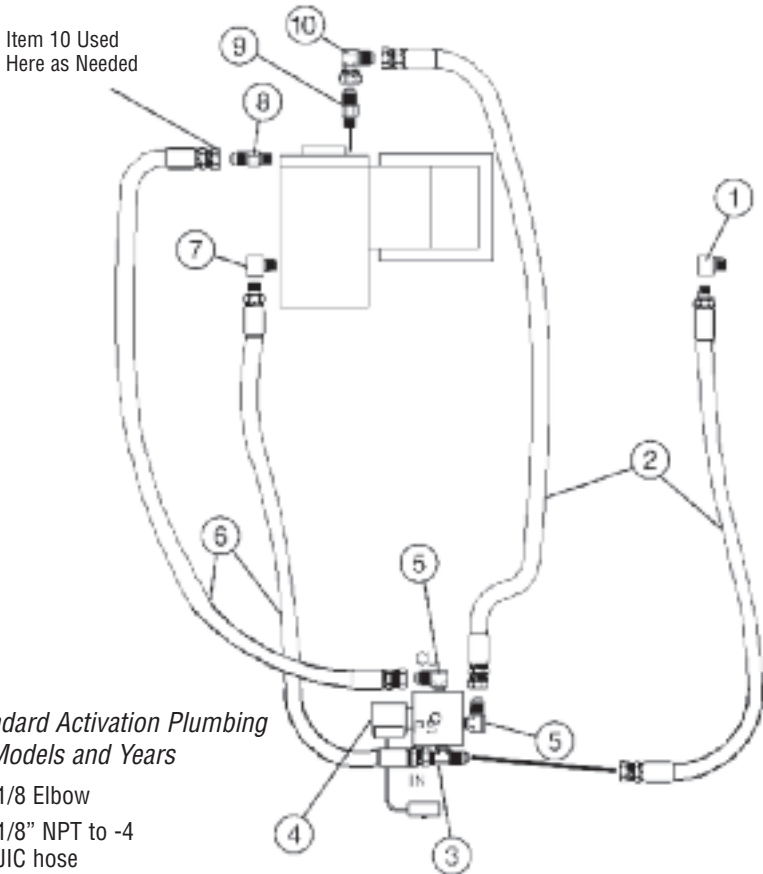

*Standard Activation Plumbing
All Models and Years*

1. 1/8 Elbow
2. 1/8" NPT to -4 JIC hose
3. -4 ODT to JIC Tee Fitting
4. 12Vdc Hydraulic Activation Solenoid
5. -4 ODT to JIC Elbow
6. -4 JIC to JIC Hose
7. 1/8" NPT .030 Orifice Elbow
8. -4 ODT to JIC Fitting
9. 1/8" NPT to JIC Fitting
10. -4 JIC to JIC Elbow

PTO INSTRUCTIONS & TESTS

1. Install the appropriate shifter kit components as described.
2. With the ignition switch on (but engine not running) turn on the PTO control switch and listen for the solenoid valve. You should be able to hear the valve snap open. If not, check for a poor ground connection. This must be a bare metal contact to battery ground.
3. Start engine and engage PTO with switch. If PTO fails to operate or will not develop enough torque to operate equipment, check pressures as follows:

a. Stop engine.

b. Install 400 PSI pressure gauge at piston port of PTO.

c. Install a second 400 PSI pressure gauge in front of the screen adapter at the solenoid valve.

d. Start engine. Stay clear of rotating components. Place PTO switch in engage position. Increase engine speed to 1300 RPM.

e. If either gauge registers less than 130 PSI, or if there is more than 50 PSI differences at any engine speed, check for obstructions in the hoses or the screen adapter.

f. If the second gauge (above) registers 50 PSI or less, you may be connected to the wrong port on the transmission. Recheck the transmission information for the main pressure tap location on your model.

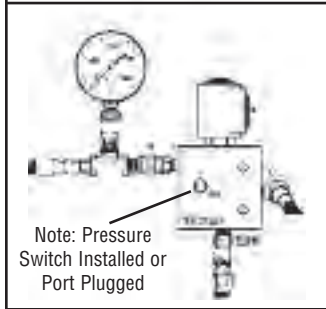
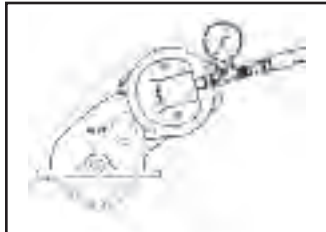

SECTION 3

OWNER'S MANUAL

PTO SHIFTING PROCEDURE & PRECAUTIONS

PTOs should not be engaged (turned "ON") under heavy load and/or at engine speeds over 1000 RPM. If your operators are careless or negligent in this respect, you can safeguard your equipment with one or more Muncie protective systems.

CAUTION: Do Not operate hydraulic pumps systems without the hydraulic system completely installed.



WARNING! STATIONARY OPERATION REQUIREMENTS:

- Parking brake must always be set
- Vehicle's wheels must always be chocked
- Transmission must always be in neutral or park

An operator must always be in the driver's seat whenever the engine is running and the transmission is in gear, in order to prevent or stop any unexpected movement of the vehicle which may cause injuries to the operator or others in the vicinity.

POWER TAKE-OFF OPERATION - VEHICLE STATIONARY

2003-2004 MODEL YEAR CHASSIS

1. See warning above. Set parking brake and with foot off of service brake, with the vehicle engine operating at idle, engage PTO by pushing the rocker switch to the engage position. Release the switch once the PTO is engaged. The rocker switch will rest in the center position.
2. Using a throttle advance device, slowly raise the engine speed to 1200 RPM minimum for Diesel engine applications and 1300 RPM minimum for Gas engine applications. The Maximum allowable operating speed is an engine speed of 2500 RPM. Connection to Ford 6.0L diesel computer through the PTO activation circuit will automatically increase engine to 1200 RPM.
3. The throttle advance system is not included with the PTO. There are after market kits available to use with Gas engines to automatically advance the engine speed. If you need assistance in obtaining a throttle advance, you can call the Ford Body Builders Advisory staff or Muncie Power Products at the number on the inside front cover of this booklet.
4. The PTO activation system is wired through the vehicle ignition. If you should leave the PTO engaged when you turn off the vehicle the PTO activation will automatically turn off. You will need to go through the activation process again once the engine is restarted.

2005 AND LATER MODEL YEAR CHASSIS

1. See warning above. Set parking brake and with foot off of service brake, with the vehicle engine operating at idle, engage PTO by pushing the rocker switch to the engage position.
2. Using the Muncie supplied wiring harness the engine speed will rise to 1200 RPM minimum for Diesel and Gas engine applications. The Maximum allowable operating speed is an engine speed of 2500 RPM.

Consult your Muncie product literature or call your nearest Muncie Power Center for information on the SPD-1000A System Protection Device. The SPD is adjustable for maximum engine speed and can also prevent engagement of your PTO at unsafe engine speeds.

The Ford instrument panel includes a temperature gauge, which monitors transmission temperature. A temperature rise occurring immediately after PTO installation should be cause to have the installation checked for the proper PTO gasket and correct transmission oil level. Allow the system to cool. Temperature increases can indicate possible system problems, application misuse, or potential failure. Have the vehicle cooling system checked by a qualified technician. PTO may need to be inspected by qualified Muncie service center.

POWER TAKE-OFF OPERATION - VEHICLE MOBILE

1. With the vehicle engine operating at idle and the parking brake set, engage the PTO by pushing the rocker switch to the "engage" position. Release the switch once the PTO is engaged. The rocker switch will rest in the center "on" position.
(2 position switch on the 2005 and Later vehicles are on/off switches.)
2. With the parking brake applied, shift the transmission into a drive or reverse selection. The PTO will stop spinning until the brake is released and the vehicle has started moving. Stopping the vehicle will cause the PTO to stop because it is torque converter dependent. Once the transmission selector is shifted to "park" or "neutral" the PTO will start to spin.
3. The Torqshift transmission is designed to allow PTO operation in all gears including over-drive.

PTO MAINTENANCE

The Power Take-Off, being an integral part of the transmission, should be serviced at the same intervals as the transmission. Changing transmission fluid should follow the interval recommended by the vehicle manufacturer for **severe** service. Transmission oil level is important. Checking for PTO leaks and checking the transmission oil level should be done on a regular basis.

The Power Take-Off is also part of a *system*. The PTO system may include the activation control parts, a driveshaft, or hydraulic pump. This PTO system requires periodic checks and service. Typically the interval for maintenance checks of the PTO system depends on the application of the system. Every time the chassis is lubricated or a mechanic is under the vehicle the PTO system should be checked and/or serviced. For severe duty PTO system applications, it is recommended that the system be checked for service every 100 hours of use (this guideline can be adjusted based on past service history once you have it established). Service should include checking and lubricating direct mount pump shaft connections. PTO gears can be checked for wear by removing the PTO. If pitting, galling, cracking, or deformation of the gears or splines has occurred, then the PTO needs to be rebuilt or replaced.

Within the first week of use, recheck installation of PTO. Check for leaks and loose mounting hardware. At regular maintenance intervals, check adjustments and lubricate moving parts, tighten and repair connections, mounting hardware. Pumps that are mounted directly to PTO output require the application of an anti-seize or a high temperature, high pressure grease. (Muncie PTOs are initially supplied with required grease.) The purpose of this grease is to help make PTO easier to service and to reduce the effects of fretting corrosion on the mating PTO and pump shafts. PTO applications under severe duty cycles and/or high torque requirements may require servicing this shaft connection by periodically re-greasing shafts. Fretting corrosion cannot be stopped by applying grease; the grease is only a deterrent.

PTO TORQUE & HORSEPOWER RATINGS

Intermittent service refers to an On-Off operation under load. If maximum horsepower and/or torque is used for extended periods of time, (5 minutes or more) this is considered "Continuous Service" and the horsepower rating of the PTO should be reduced by multiplying the value below by .70.

PTO SERIES	SPEED RATIO	INTERMIT. HP@1000 RPM	INTERMIT. KW@1000 RPM	TORQUE LBS.FT.	TORQUE NM	MAX. SPEED
FR62	06	29	22	150	203	2500
FR63	06	36	27	190	257	2500
FR64	06	36	27	190	257	2500

PTO TROUBLESHOOTING GUIDE

PROBLEM	POSSIBLE CAUSE	REMEDY	PREVENTION
FR SERIES PTOS			
PTO does not engage	Ford required wiring installation not followed	Inspect and reconnect PTO activation wire connection on the PTO harness	Refer to wiring diagram appropriate to your model year.
	Contaminated hydraulic activation lines	Remove contaminants from piston area	Change transmission oil filter
	Transmission hydraulic pressure not high enough	Hydraulic line connected to the wrong port	Review installation diagrams on page 2.1
	Burned or extremely worn clutch pack	Replace worn components	Use proper shift procedures
	Rocker switch incorrectly connected	Remove connection at rocker switch, check pins and re-install per instructions on Step 46	Make sure green wire in connector is at the top when installed
PTO does not disengage	Faulty hydraulic solenoid valve	Repair or replace	Sometime a result of contamination or dirty valve
	Burned or extremely worn clutch pack	Repair or replace components	Follow proper engagement procedures. See page 3.1
PTO engages Low/No output speed or pump flow	Ford required wiring installation not followed	Inspect and reconnect PTO activation wire connection on the PTO harness	Refer to wiring diagram appropriate to your model year.
	Transmission selector in drive mode and operator foot on brake or parking brake set	Operate PTO in neutral or park. Operation will only occur while vehicle is moving due to torque converter slip	Refer to operating instructions on Pages 3.1 & 3.2

POWER TAKE-OFF WARRANTY

The Muncie Power Take-Off is warranted to be free of defects in material or workmanship and to meet Muncie's standard written specifications at the time of sale. Muncie's obligation and liability under this warranty is expressly limited to repairing or replacing, at Muncie's option, within one year after date of original installation any defective part or parts or any product not meeting the specifications.

THIS WARRANTY IS IN LIEU OF ALL OTHER WARRANTIES, EXPRESSED OR IMPLIED. MUNCIE MAKES NO WARRANTY OF MERCHANTABILITY OR OF FITNESS FOR ANY PARTICULAR PURPOSE. MUNCIE'S OBLIGATION UNDER THIS WARRANTY SHALL NOT INCLUDE ANY TRANSPORTATION CHARGES OR COSTS OF INSTALLATION OR ANY LIABILITY FOR DIRECT, INDIRECT SPECIAL, INCIDENTAL, OR CONSEQUENTIAL DAMAGES OR DELAY. THE REMEDIES SET FORTH HEREIN ARE EXCLUSIVE, AND MUNCIE'S LIABILITY WITH RESPECT TO ANY CONTRACT OR SALE OR ANYTHING DONE IN CONNECTION THEREWITH, WHETHER IN CONTRACT, IN TORT, UNDER ANY WARRANTY, OR OTHERWISE, SHALL NOT, EXCEPT AS EXPRESSLY PROVIDED HEREIN, EXCEED THE PRICE OF THE PRODUCT OR PART ON WHICH SUCH LIABILITY IS BASED.

If requested by Muncie, products or parts for which a warranty claim is made are to be returned transportation prepaid to a Muncie Service Center. Any installation or use not in accordance with catalogue or package instructions, other improper use, operation beyond capacity, substitution of parts not approved by Muncie, use with equipment other than the equipment on which the Power Take-Off is first installed, or alteration or repair made to the Power Take-Off other than at a Muncie Service Center shall void this warranty. No employee or representative of Muncie is authorized to change this warranty in any way or to grant any other warranty.

3.4



**Muncie®
Power
Products**



Muncie Power Products, Inc. *Member of the Interpump Hydraulics Group*

General Offices and Distribution Center • P.O. Box 548 • Muncie, IN 47308-0548 • (765) 284-7721
FAX (765) 284-6991 • E-mail info@munciepower.com • Web site <http://www.munciepower.com>

Drive Products, Exclusive Agents for Canada, *ISO Certified by an Accredited Registrar*

IN03-01 (Rev. 10-08) Printed in the U.S.A.

Pro **Gear**

AND TRANSMISSION, INC.

If you have any questions about any Munice Product, do not hesitate to call us so we can help you with finding the right PTO, part or anything else you may need.

906 West Gore St
Orlando, FL 32805
USA

Contact Us:

1-866-776-4600

1-407-872-1901

Fax:

1-407-872-6235