

BROUGHT TO YOU BY PRO GEAR &
TRANSMISSION.

FOR PARTS OR SERVICE CALL:

877-776-4600

407-872-1901



Roadranger®



EATON

SPICER®



WWW.PGTTRUCKPARTS.COM

906 W. GORE ST. ORLANDO, FL 32805

PARTS@EPROGEAR.COM



Revised 05-98

13-Speed Manual Transmission

Operator Manual TP-90192

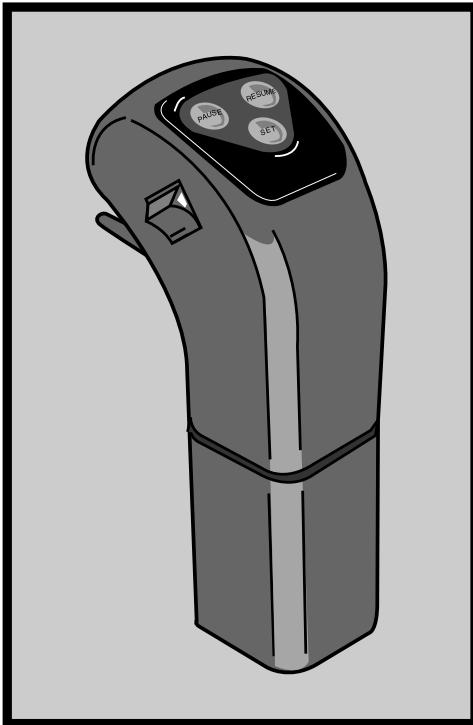

Table of Contents

Introduction	2
Shift Knob	4
Shift Decal	5
General Transmission Operating Information	6
How to Shift the Transmission	7
Starting the Vehicle	7
Shifting into REVERSE	8
Initial Shifting into LO Gear	9
Upshifting in the LO Range	10
Upshifting in the HI Range	11
Downshifting	13
Parking	17
Transmission Temperature Indicator Gauges or Lights	17
When to Shift the Transmission	18
Troubleshooting	20
Specifications	22
Oil Capacities	22
Oil Specifications	22
Ratios and Steps	23
Shift-n-Cruise™ Operating Instructions	24

Introduction

The ZF Meritor RMO-13-145A thirteen-speed manual transmission uses a range lever and splitter button on the shift knob to select the thirteen forward speeds and the two reverse speeds. **See the chart in Figure 2.**

See the chart in Figure 1 for an explanation of the transmission model number.

Refer to the Operator's Guide from the manufacturer of the vehicle for all the procedures that are required to safely operate and use the vehicle.

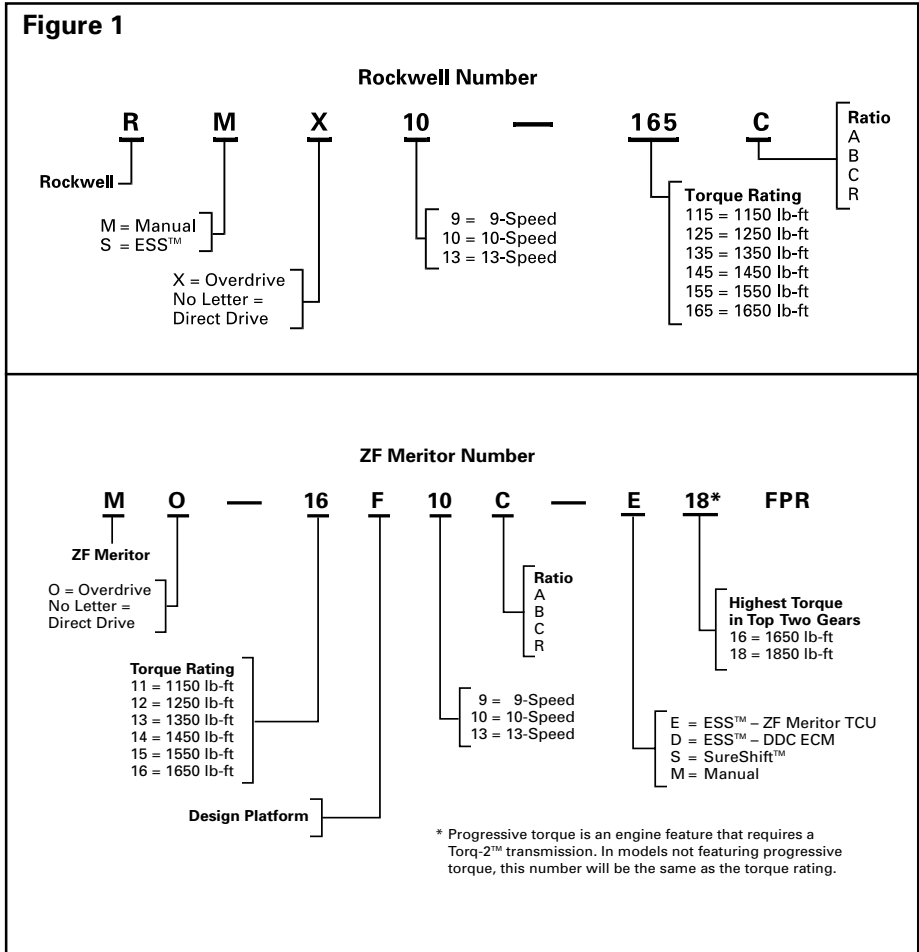

Figure 2

Speed Number	Decal Marking	Range Lever Position	Splitter Button Position
1	LO	LO	Direct
2	1	LO	Direct
3	2	LO	Direct
4	3	LO	Direct
5	4	LO	Direct
6	5	HI	Direct
7	5OD	HI	Overdrive
8	6	HI	Direct
9	6OD	HI	Overdrive
10	7	HI	Direct
11	7OD	HI	Overdrive
12	8	HI	Direct
13	8OD	HI	Overdrive
Reverse	R	LO	—
Reverse	R	HI	Direct

NOTE

Use the LO range in reverse for all reverse driving conditions. The use of the HI range in reverse is not recommended.

Shift Knob

The range lever and the splitter button are on the shift knob.

Push the blue range lever down to select the **LO** range. Pull the blue range control lever up to select the **HI** range. **Figure 3.**

The red splitter button is activated only when the blue range lever is in the **HI** range position (lever pushed up). The splitter button cannot be activated when the **LO** range is selected. The red button is a two position switch. To select the **DIR (Direct)** range push the red button in toward the bottom of the shift knob. To select the **OD (Overdrive)** range push the red button in toward the top of the shift knob. The shift lever does not have to be moved when the **DIR (Direct)** and **OD (Overdrive)** ranges are selected. **Figure 4.**

Figure 4.

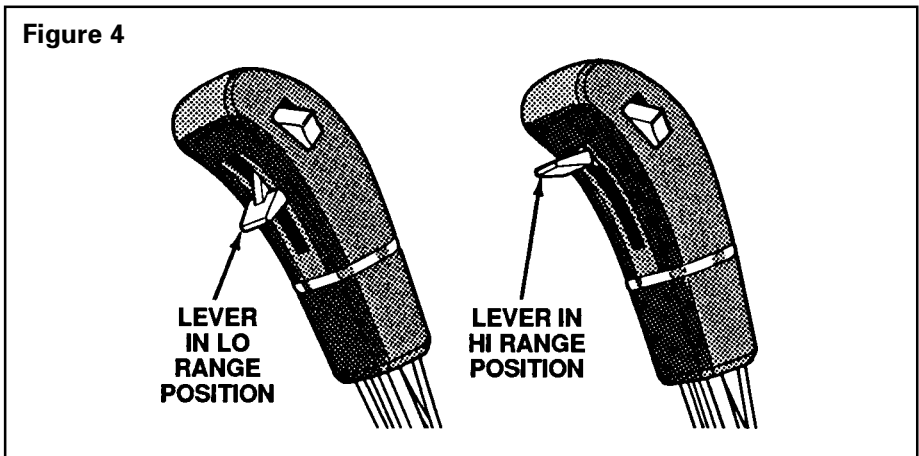
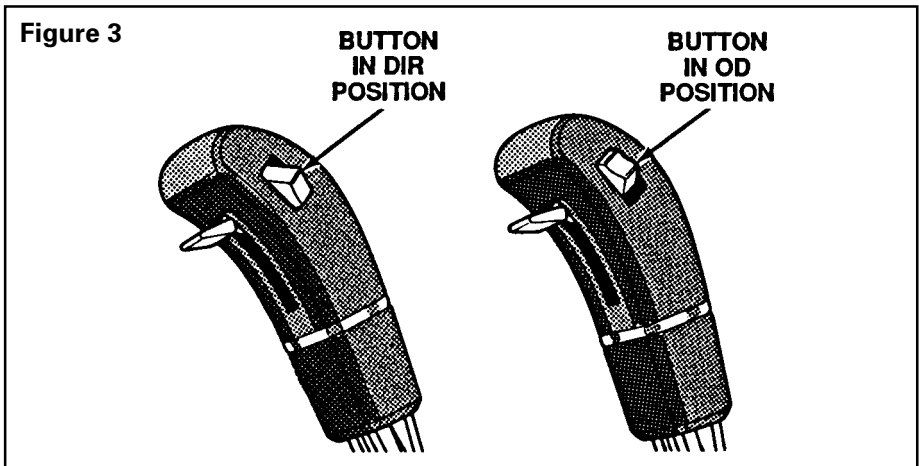

Shift Decal

A decal with the shift pattern and operating instructions is found on the sun visor or the instrument panel. Refer to the decal when shifting the transmission. **Figure 5.**



CAUTION

Always remember to use the correct shift pattern. Shift patterns can be different in other trucks. If the transmission is not shifted correctly, the transmission can be damaged. If the decal is missing or damaged, install a new decal (ZF Meritor Part Number 2297-F-6168).

Figure 5

13-Speed Transmission

Upshifting

- Start with range selector in **DOWN** position
- Shift LO-1-2-3-4
- Raise range control while in 4th
- Shift to 5-6-7-8
- Splitter can be operated in 5-6-7-8 only

Downshifting

- Shift 8-7-6-5
- Move range control **DOWN** while in 5th
- Shift 4-3-2-1-LO

DO NOT MOVE RANGE CONTROL WHILE MOVING IN REVERSE

SPLITTER CONTROL

RANGE CONTROL

2297-F-6168

13-Speed Transmission

Upshifting

- Start with range selector in **DOWN** position
- Shift LO-1-2-3-4
- Raise range control while in 4th
- Shift to 5-6-7-8
- Splitter can be operated in 5-6-7-8 only

Downshifting

- Shift 8-7-6-5
- Move range control **DOWN** while in 5th
- Shift 4-3-2-1-LO

DO NOT MOVE RANGE CONTROL WHILE MOVING IN REVERSE

SPLITTER CONTROL

RANGE CONTROL

General Transmission Operating Information



WARNING

Use the information in this section (GENERAL TRANSMISSION OPERATING INFORMATION) to prevent personal injury and/or damage.

Use the clutch brake for initial gear engagement when the vehicle is standing still. If the clutch brake is used when the vehicle is moving, the tabs of the clutch brake can break and damage the input shaft and the transmission. If the clutch brake is not correctly used when the vehicle is stopped, the **LO** and **REVERSE** sliding collar, the clutch brake or the input shaft can be damaged.

Do not coast in NEUTRAL with the clutch disengaged. Coasting in **NEUTRAL** may cause a loss of vehicle control. Coasting in **NEUTRAL** does not allow lubricants to go to the thrust washers. This damages the thrust washers and the mainshaft.

Downshift to a lower gear when going down a hill or grade. Downshifting to a lower gear when going down a hill or grade slows the vehicle down without excessive brake usage. If you do not downshift when going down a hill or grade, the brakes may overheat. Brakes that overheat may not stop the vehicle and cause personal injury and damage.

Use the clutch when changing gears. If the clutch is not used, the gear teeth “grind” instead of mesh. “Grinding” damages the shift forks, sliding collars and gears and makes the transmission hard to shift. The metal particles from the damaged parts fall in the lubricant and damage the bearings. Damage from not using the clutch can also make the transmission slip out of gear.

Use the correct gear. If the correct gear is not selected, a shock load can damage the gear teeth immediately or cause damage which may appear later.

Shift at the correct RPM. Always shift at the correct engine speed (RPM) to get the best and most economical operation. Use the Torque Split Chart from the manufacturer of the vehicle. See a typical chart in **Figure 15**.

Shift the range selector when the transmission is in gear. When the range selector lever is shifted with the transmission in gear, the mainshaft and the output shaft are rotating at the same speed. When the range selector is shifted with the transmission in **NEUTRAL**, the mainshaft is rotating at engine speed and the output shaft is rotating at road speed. This damages the synchronizer assembly in the auxiliary cover.

Push the splitter button when the transmission is in gear. If the splitter button is pushed when the transmission is in **NEUTRAL**, the gear speeds will not match. If the gear speeds are not matched, the sliding collar can be damaged.



WARNING

Use the information in this section (GENERAL TRANSMISSION OPERATING INFORMATION) to prevent personal injury and/or damage.

Immediately depress the clutch pedal and/or lightly release the accelerator pedal when selecting the splitter range. If the clutch is not depressed immediately, the shift forks may be damaged. If the accelerator is not released, the shock load may damage the sliding collars.

Drain the moisture from the air reservoir every day. If moisture is not removed from the air supply system, moisture and contaminants enter the system. Moisture and contaminants cause the system not to operate correctly and damages the components of the system.

Remove the axle shafts when towing the vehicle with the rear wheels on the ground. If the axle shafts are not removed the mainshaft thrust washers in the transmission and the pinion bearings in the axle will be damaged. The thrust washers and the pinion bearings will not get lubrication because of the towing angle.

How to Shift the Transmission

Starting the Vehicle

Before starting the vehicle, make sure of the following:

1. The engine oil is at the specified level.
2. The transmission is in **NEUTRAL**.

When starting the vehicle, make sure of the following:



WARNING

The transmission must be NEUTRAL (N) when the vehicle is started. If the vehicle is started with the transmission in gear, the vehicle will suddenly move forward or rearward and may cause personal injury and damage.

1. Make sure the shift lever is in the **NEUTRAL** position.
2. Push the clutch pedal to the bottom of travel.
3. Start the engine. Let the air pressure in the air system reach the specified range on the gauge.
4. Release the parking brakes.

! CAUTION

Always use the correct gear when operating the transmission. Do not shift into NEUTRAL and coast or you will damage the transmission.

Shifting into REVERSE

! CAUTION

Move the range lever when the vehicle is standing still.

1. Push the range lever into the LO range. **Figure 6**. Use the LO range in reverse for all reverse driving conditions. The use of HI range is not recommended.

! CAUTION

Use the clutch brake only for initial gear engagement when the vehicle is standing still or you will damage the input shaft and/or the clutch brake.

2. Push the clutch pedal to the bottom of travel so that the clutch brake touches the release bearing of the clutch and that the clutch is disengaged. This slows down the transmission for initial gear engagement.
3. With the clutch pedal at the bottom of travel, move the shift lever into the REVERSE (R) position. **Figure 8**.
4. Slowly release the clutch pedal to move the vehicle in the reverse direction.

Figure 6

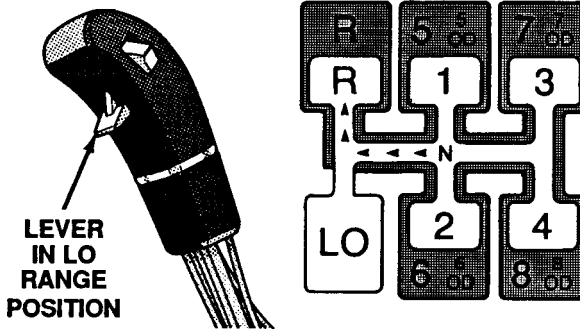

Initial Shifting into LO Gear

Use **LO** gear when moving a **loaded** vehicle from a stopped position up a grade.

1. Push the range lever down into the **LO** range. **Figure 7.**



CAUTION

Use the clutch brake only for initial gear engagement when the vehicle is standing still or you will damage the input shaft and/or the clutch brake.

2. Push the clutch pedal to the bottom of travel so that the clutch brake touches the release bearing of the clutch and that the clutch is disengaged. This slows down the transmission for initial gear engagement.
3. With the clutch pedal at the bottom of travel, move the shift lever into the **LO** position. **Figure 7.**

Figure 7

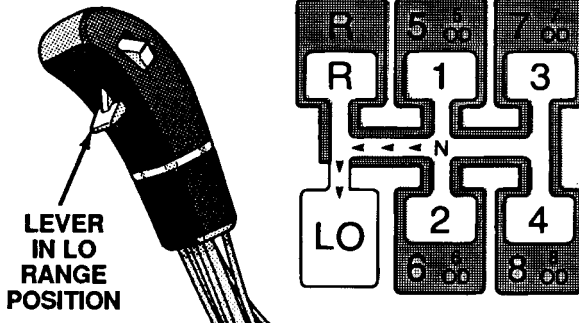

4. Release the clutch pedal.
5. When ready to upshift into **first (1) gear**, do the following:
 - a. Release the accelerator.
 - b. Depress the clutch pedal until the clutch is disengaged. **Do not depress the clutch pedal to the bottom of travel.**
 - c. Move the shift lever to the **NEUTRAL** position.
 - d. Release the clutch pedal.
 - e. Let the engine slow down to the correct RPM.

- f. Depress the clutch pedal until the clutch is disengaged. **Do not depress the clutch pedal to the bottom of travel.**
- g. Move the shift lever to the **first (1) gear** position. **Figure 7.**
- h. Release the clutch pedal and apply the accelerator.

Upshifting in the LO Range

To upshift into the **second (2), third (3) and fourth (4) gears**, do the following:

- 1. Make sure the range lever is in the LO range. **Figure 8.**
- 2. Release the accelerator.
- 3. Depress the clutch pedal until the clutch is disengaged. **Do not depress the clutch pedal to the bottom of travel.**
- 4. Move the shift lever to the **NEUTRAL** position.
- 5. Release the clutch pedal.
- 6. Let the engine slow down to the correct RPM.
- 7. Depress the clutch pedal until the clutch is disengaged. **Do not depress the clutch pedal to the bottom of travel.**
- 8. Move the shift lever to the **correct gear** position. **Figure 8.**
- 9. Release the clutch pedal and apply the accelerator.

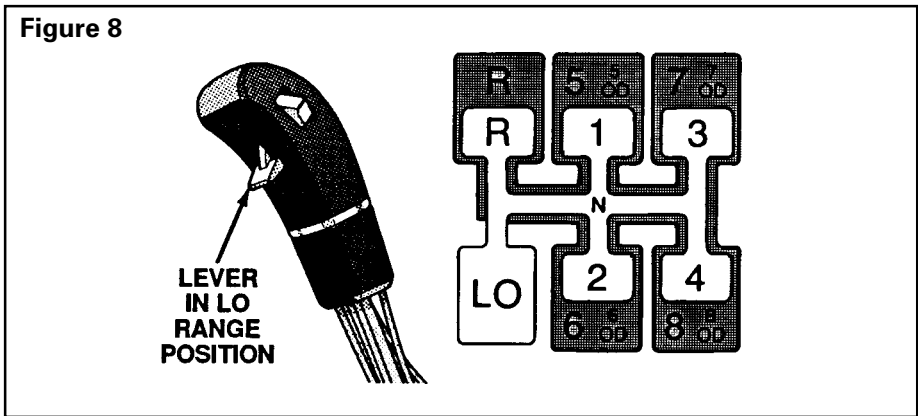

Upshifting in the HI Range

When ready to upshift into **fifth (5) gear**, do the following:



CAUTION

Move the range lever only when the transmission is in gear or you will damage the transmission.

1. While in **fourth (4) gear**, move the range lever up into the **HI** range. **Figure 9.**
2. Release the accelerator.
3. Depress the clutch pedal until the clutch is disengaged. **Do not depress the clutch pedal to the bottom of travel.**
4. Move the shift lever to the **NEUTRAL** position. The range cylinder will automatically shift into the **HI** range when the lever is in the **NEUTRAL** position.
5. Release the clutch pedal.
6. Let the engine slow down to the correct RPM.
7. Depress the clutch pedal until the clutch is disengaged. **Do not depress the clutch pedal to the bottom of travel.**
8. Move the shift lever to the **fifth (5) gear** position. **Figure 9.**
9. Release the clutch pedal and apply the accelerator.

Figure 9

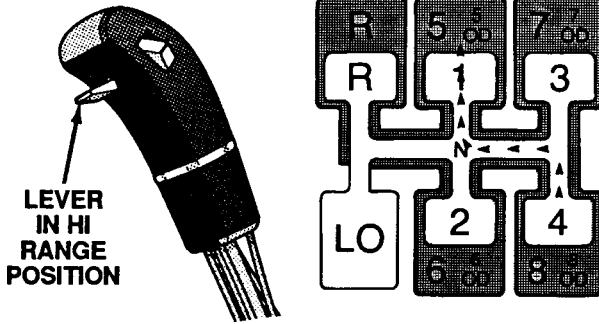

10. To shift (or split the gear) into **fifth overdrive (5OD)**, do the following: **Figure 10**.

- a. Push the red splitter button on the knob in the **overdrive (OD)** position and immediately depress the clutch pedal until the clutch is disengaged and release the accelerator pedal. **Do not depress the clutch pedal to the bottom of travel.**
- b. Release the clutch pedal and apply the accelerator pedal.

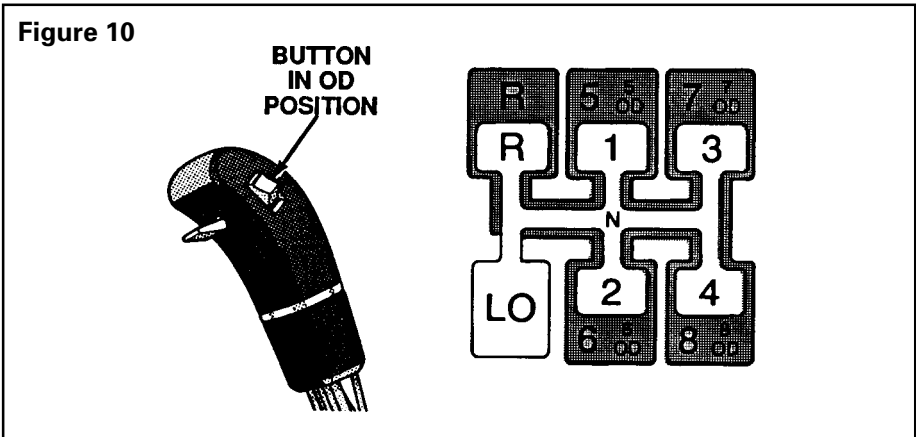

11. To shift from **fifth overdrive (5OD)** to **sixth direct (6)** gear, do the following: **Figure 11**.

- a. Release the accelerator and immediately depress the clutch pedal until the clutch is disengaged. **Do not depress the clutch pedal to the bottom of travel.**
- b. Move the shift lever to the **NEUTRAL** position.
- c. Release the clutch pedal.
- d. Let the engine slow down to the correct RPM.
- e. Depress the clutch pedal until the clutch is disengaged. **Do not depress the clutch pedal to the bottom of travel.**
- f. Move the shift lever to the **sixth (6)** position.
- g. Push the red splitter button on the knob in the **direct (DIR)** position and immediately release the clutch pedal and apply the accelerator pedal.

Figure 11

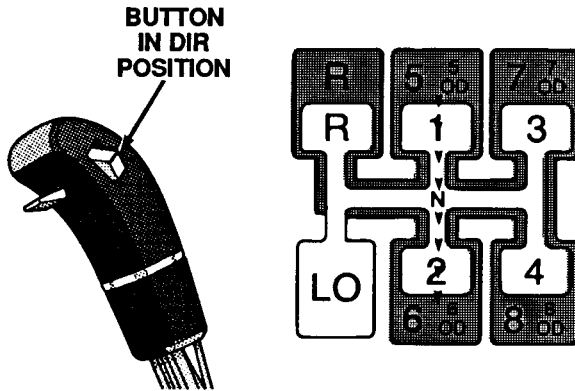

12. To shift from **direct** into **overdrive (OD)** in the same gear, see step 10 of this procedure.
13. To shift from **overdrive (OD)** into **direct** of the next gear, repeat step 11 of this procedure only put the shift lever in the correct position.

Downshifting

1. To downshift from **eighth overdrive (8OD)** to **eighth direct (8)** gear, do the following: **Figure 12**.
 - a. Push the red splitter button on the knob in the direct position and immediately release the accelerator and depress the clutch pedal until the clutch is disengaged. **Do not depress the clutch pedal to the bottom of travel.**
 - b. Release the clutch pedal and apply the accelerator.

Figure 12

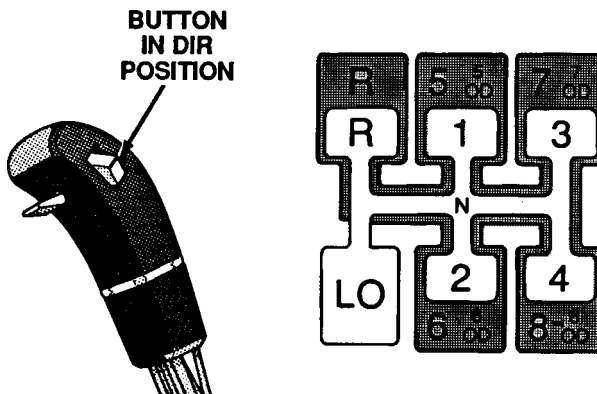

2. When ready to downshift from **eighth direct (8) to seventh overdrive (7OD) gear**, do the following: **Figure 13**.
 - a. Release the accelerator.
 - b. Depress the clutch pedal until the clutch is disengaged. **Do not depress the clutch pedal to the bottom of travel.**
 - c. Move the shift lever to the **NEUTRAL** position.
 - d. Release the clutch pedal.
 - e. Apply the accelerator to increase the engine speed to the correct RPM.
 - f. Release the accelerator and immediately depress the clutch pedal until the clutch is disengaged. **Do not depress the clutch pedal to the bottom of travel.**
 - g. Move the shift lever to the **seventh (7) gear** position.
 - h. Push the red splitter button on the knob in the **overdrive (OD)** position and immediately release the clutch pedal and apply the accelerator.

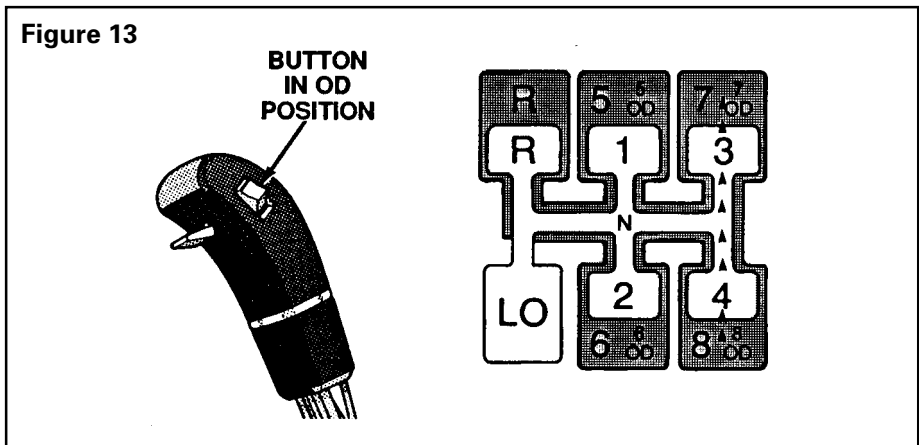

3. To downshift from **overdrive** to **direct** in the same gear, repeat step 1 of this procedure.
4. To downshift into the **sixth (6) and fifth (5) gears**, repeat step 2 only put the lever in the correct **sixth (6) and fifth (5) gear** positions.

5. When ready to downshift from **fifth direct (5)** into **fourth (4)** gear, do the following:

CAUTION

Shift the range selector only when the transmission is in gear. Do not shift the range selector when the transmission is in NEUTRAL.

- While in **fifth direct (5)** gear, shift the range selector valve to the **LO** range by moving the lever down. **Figure 14.**
- Release the accelerator.
- Depress the clutch pedal until the clutch is disengaged. **Do not depress the clutch pedal to the bottom of travel.**
- Move the shift lever to the **NEUTRAL** position. The range cylinder will automatically shift into the **LO** range when the lever is in the **NEUTRAL** position.
- Release the clutch pedal.
- Apply the accelerator to increase the engine speed to the correct RPM.
- Depress the clutch pedal until the clutch is disengaged and release the accelerator. **Do not depress the clutch pedal to the bottom of travel.**
- Move the shift lever to the **fourth (4)** gear position. **Figure 14.**
- Release the clutch pedal and apply the accelerator.

Figure 14

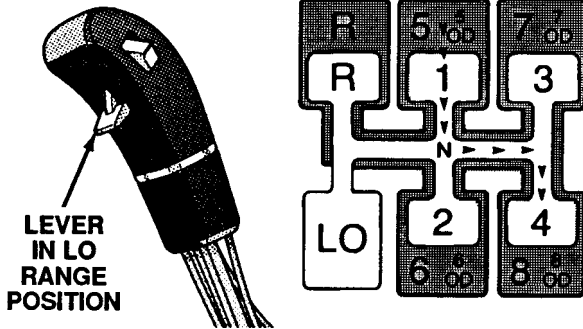

6. To downshift into the **third (3), second (2), first (1) and LO gears**, do the following. **Figure 15.**
- Release the accelerator.
 - Depress the clutch pedal until the clutch is disengaged. **Do not depress the clutch pedal to the bottom of travel.**
 - Move the shift lever to the **NEUTRAL** position.
 - Release the clutch pedal.
 - Apply the accelerator to increase the engine speed to the correct RPM.
 - Depress the clutch pedal until the clutch is disengaged and release the accelerator. **Do not depress the clutch pedal to the bottom of travel.**
 - Move the shift lever to the correct position.
 - Release the clutch pedal and apply the accelerator.

Figure 15

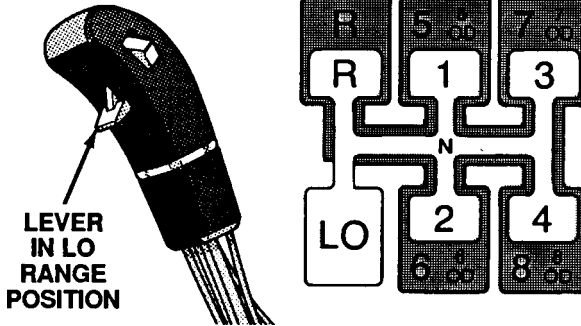

Parking



WARNING

Put the transmission in NEUTRAL (N) and use the approved parking procedure of the manufacturer of the vehicle when parking the vehicle. Do not leave the transmission in gear to park the vehicle. If the transmission is used as a parking brake, the vehicle can move and cause personal injury and damage.

Vehicles may use a knob or a lever to apply the parking brake. See the procedure of the manufacturer of the vehicle. Make sure the transmission is in the NEUTRAL (N) position after the vehicle is parked.

Transmission Temperature Indicator Gauges or Lights



CAUTION

The transmission may be damaged if the vehicle is operated when the transmission indicator light is "ON" or the indicator of the gauge is in the warning area. Stop the vehicle and look for the cause of the overheating. Service the overheating condition as necessary.

Vehicles may use an optional transmission temperature light or a gauge. The temperature indicator light goes "ON" when the transmission is overheating during vehicle operation. The temperature gauge shows the complete temperature range during vehicle operation. For more information see the Operator's Guide of the vehicle.

When to Shift the Transmission

For smooth shifting and longer drivetrain life, shift the transmission at the correct engine speed (RPM) or the correct road speed (MPH).

If the transmission is not shifted at the correct RPM or MPH, then a “grinding” noise may come from the transmission.

Shift the transmission when the vehicle speed will not increase and the engine is at the rated RPM.

To find the correct RPM or MPH for shifting, see the torque split chart from the manufacturer of the vehicle. A typical torque chart is shown in **Figure 16**. The torque split chart can be different on each vehicle because the information is determined by the engine specifications, the rear axle ratio and the tire size.



CAUTION

If the engine, the rear axle or the tires are changed from the original equipment of the vehicle, a new torque split chart must be obtained.

Figure 16 Torque Split Chart Example – GOVERNED RPM:1800, REAR AXLE RATIO:4.10, TIRE SIZE: 11.00-22R

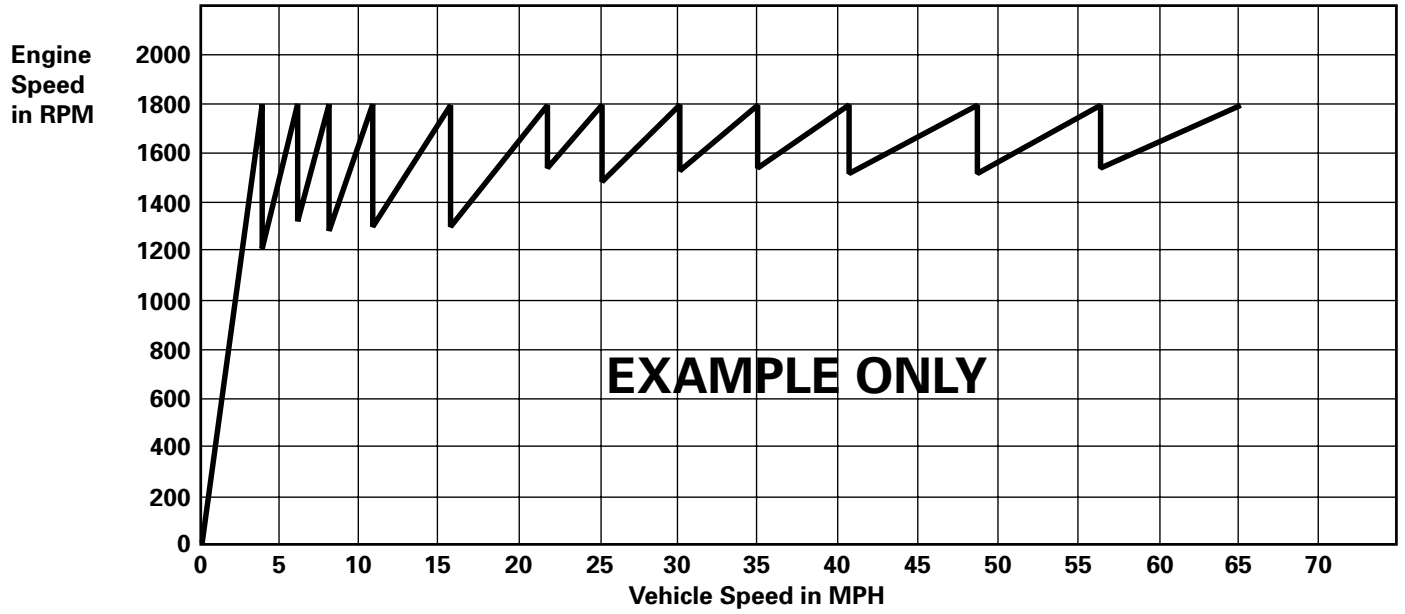

Troubleshooting

If the transmission slips out, shifts slowly or cannot shift into the selected range, check the tubes in the air shift system for damage or leaks. Also make sure the tubes are correctly installed. **If the tubes are not damaged and do not leak, the vehicle must be serviced.**

To remove and replace tubes, see the following:

1. Remove the air from the air supply system.
2. Use a small screwdriver to push the button on the top of the fitting. Pull the tube from the fitting. **Figure 17.**
3. Cut the ends of the new tube square.
4. To install the tube, push the tube into the fitting until the tube touches the bottom of the fitting. The button on the top of the fitting automatically locks the tube in position. **Figure 18.**
5. Operate the vehicle. Check for leaks.

To check for correct tube installation, see **Figure 19.**

Figure 17

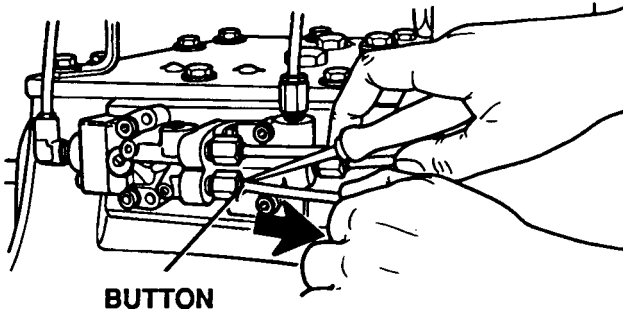

Figure 18

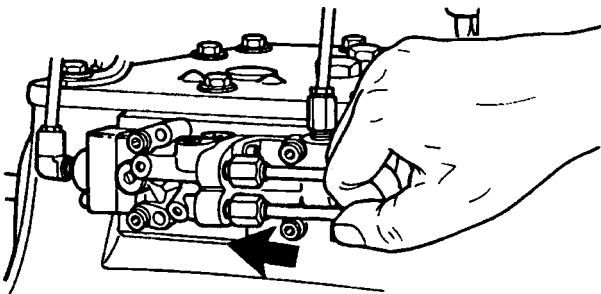
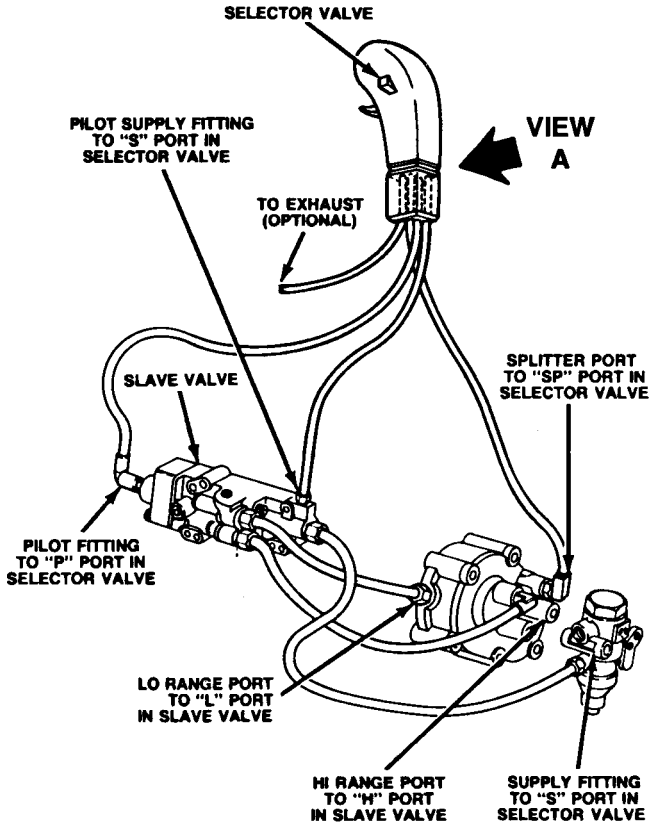
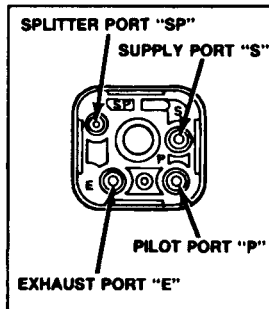

Figure 19



VIEW A



Specifications

Transmission Oil Capacities*

Transmission Model	U.S. Pints	Liters
RMO-13-145A	20	9.5

* Oil capacities are approximate. Fill the transmission to the bottom of the fill plug hole. On transmissions equipped with an oil pump and/or oil cooler, operate the engine for five minutes after the initial fill and check the oil level again.

Transmission Oil Specifications

Oil Type	Grade (SAE)	Outside Temperature
Heavy Duty Engine Oil MIL-L-2104B, C or D O or API-SF, -SG, -CD or -CE (Previous API Designations Acceptable)*	50	Above 10°F (-12° C)
	40	Above 10°F (-12° C)
	30	Below 10°F (-12° C)
Mineral Gear Oil with Rust and Oxidation Inhibitor (API-GL-1)*	90	Above 10°F (-12° C)
	80	Below 10°F (-12° C)
Synthetic Oil Meritor Spec. 0-81*	50	All

* Multi-weight and EP gear oils are not recommended. **DO NOT MIX OILS IN THE TRANSMISSION.**

RMO-13-145A Transmission Ratios and Steps

TORQUE RATING (LB-FT)	OVERALL RATIO	REVERSE L (LO) RATIO	REVERSE H (HI) RATIO
1,450	15.43	13.15	3.73

SPEED NUMBER	DECAL MARKING	RATIO	PERCENT STEP
L	L	13.39	48
1	1	9.03	39
2	2	6.50	37
3	3	4.74	34
4	4	3.53	38
5	5	2.56	15
6	5OD	2.22	20
7	6	1.84	15
8	6OD	1.60	19
9	7	1.34	15
10	7OD	1.16	16
11	8	1.00	15
12	8OD	0.87	-

Shift-n-Cruise™ Operating Instructions

ZF Meritor's Shift-n-Cruise™ shift knob is available on vehicles equipped with a manual transmission and a cruise control system. It allows the driver to select cruise control operations from the transmission shift knob.



CAUTION

Only use your finger to press the PAUSE, RESUME or SET buttons on the Shift-n-Cruise™ shift knob. Items such as a screwdriver, ballpoint pen or any sharp object can cause a button to become stuck in the switch assembly. The cruise control system will not operate correctly. Damage to components can also result.

The PAUSE, RESUME and SET controls are located on the top of the shift knob. The ON/OFF controls are located on the instrument panel.



WARNING

Do not use the Shift-n-Cruise™ system in heavy traffic or on roads that are winding, wet and/or slippery. These conditions affect cruise control performance, which can result in loss of vehicle control, serious personal injury and vehicle damage. For complete cruise control operating instructions, refer to the vehicle operator's manual.

- Use the SET button to select cruise control speed.
- Use the PAUSE button to temporarily deactivate cruise control operation.
- Use the RESUME button to reactivate cruise control to a selected speed after you press the PAUSE button.



ZF Meritor, LLC

22021 Skyway Church Road
Maxton, NC 28364 USA
800-535-5560
www.arvinmeritor.com

Information contained in this publication was in effect at the time the publication was approved for printing and is subject to change without notice or liability. ZF Meritor, LLC, reserves the right to revise the information presented or discontinue the production of parts described at any time.

Copyright 1998
ZF Meritor, LLC
All Rights Reserved

Printed in the USA

TP-90192
Revised 05-98
16579/24240